

**OKAMURA CORPORATION**  
**INTERNATIONAL SALES & MARKETING DIVISION**

**TOKYO INTERNATIONAL BRANCH**

**Location** 26F, New Otani GARDEN COURT, 4-1 Kioi-cho,  
Chiyoda-ku, Tokyo, 102-0094, Japan

**Tel** +81-3-6743-4530

**Email** okm\_global@okamura.co.jp

[www.okamura.com](http://www.okamura.com)



The products listed in this catalog are available as of July 2024.  
Please note that specifications, dimensions, and colors are subject  
to change without notice. The colors of the actual products may  
differ somewhat from the colors shown in the catalog, depending  
on printing conditions.

okamura

Loving  
people,  
creating  
places

**okamura**



# Loving people, creating places

To increase the number of people who can live their lives in their own way, and to build a society full of smiles, Okamura will continue loving people and creating places where they can thrive.



Okamura was established in 1945 by a group of engineers. Mikasa, Japan's first automatic front wheel drive car, developed by Okamura in 1955. The spirit of craftsmanship contributes to an environment where working people can thrive.

# INTRODUCTION OF OKAMURA



**79**  
YEARS  
IN BUSINESS



**3,844**  
EMPLOYEES



OVER  
**USD 2.4 BN**  
SALES  
(CONSOLIDATED)



**34**  
GROUP  
COMPANIES



OVER  
**50**  
COUNTRIES  
DISTRIBUTED



**703**  
DESIGN  
AWARDS

**1945** Okamura founded in  
Yokohama City, taking  
the name of its location  
in Okamura Town.



**'48** Started manufacturing  
garden tables and chairs.

**'50** Began production of  
torque converters for  
trains, cars, and  
industrial vehicles.

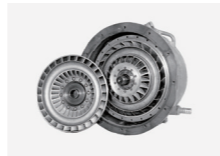

**'58** Oppama Plant  
established.

**'57** Steel office desks and  
chairs launched



**'55** Developed Japan's first  
front-wheel-drive  
automatic, the Mikasa.

**'53** The N-52, Japan's  
first postwar airplane,  
completed.



**'69** Began sales of Japan's  
first colored desks and  
chairs, the Type-33 and  
the Type-21.

**'70** Tokyo showroom opened



**'86** Ergonomic chair  
launched



**'09** Okamura Museum  
opened.



**'08** Chicago Showroom  
opened. Participated in  
NeoCon 2008.

**'02** Contessa ergonomic  
mesh chair announced.



**'96** Siam Okamura  
International Co., Ltd.  
established in Thailand.

**'20** Okamura International  
Vietnam Co., Ltd.  
established.



**'22** Ha Noi branch  
established

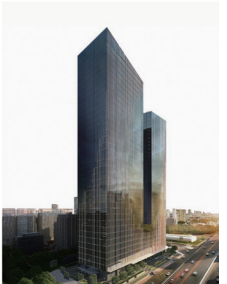

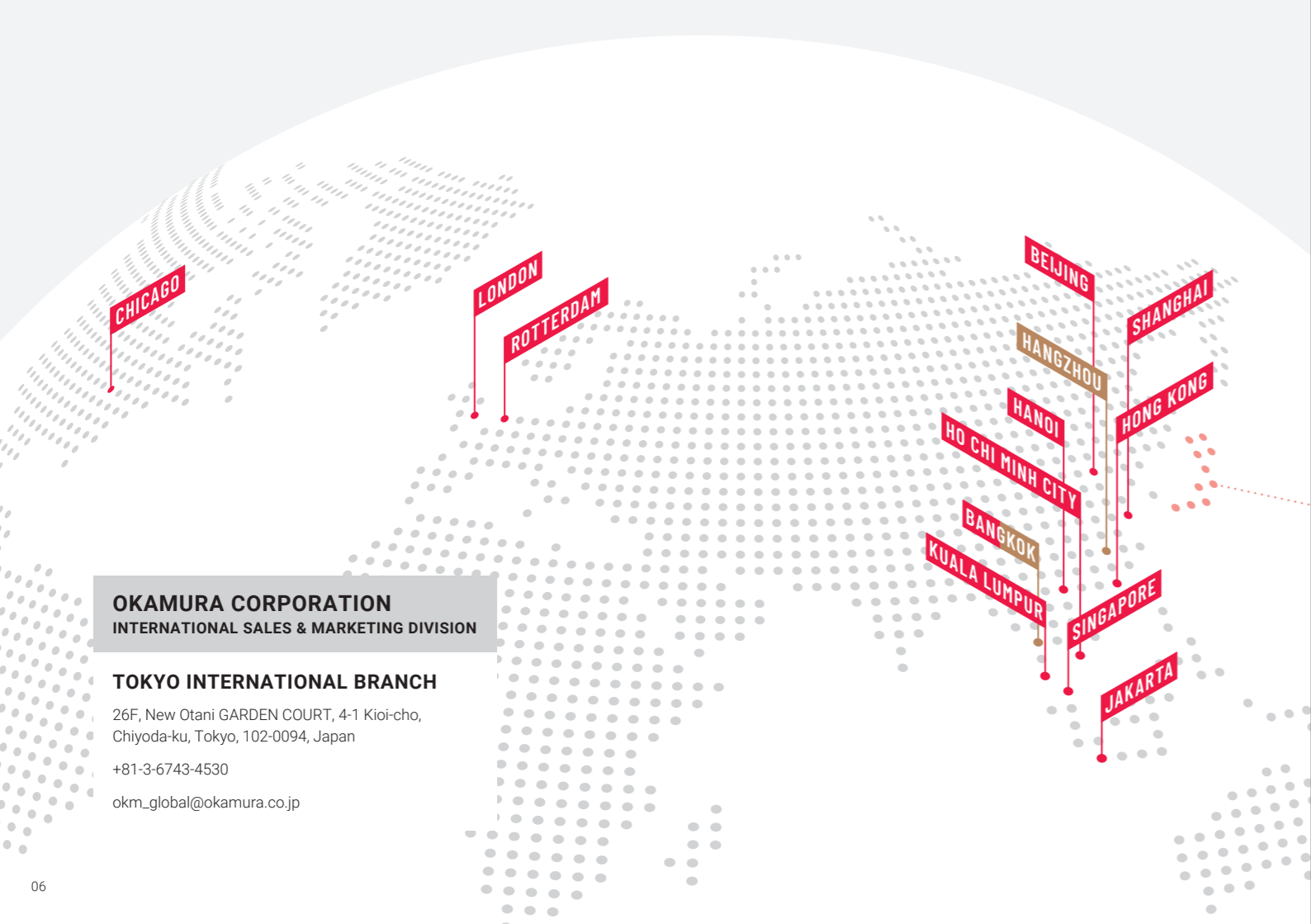

**OKAMURA CORPORATION**  
INTERNATIONAL SALES & MARKETING DIVISION

**TOKYO INTERNATIONAL BRANCH**  
26F, New Otani GARDEN COURT, 4-1 Kioi-cho,  
Chiyoda-ku, Tokyo, 102-0094, Japan  
+81-3-6743-4530  
okm\_global@okamura.co.jp

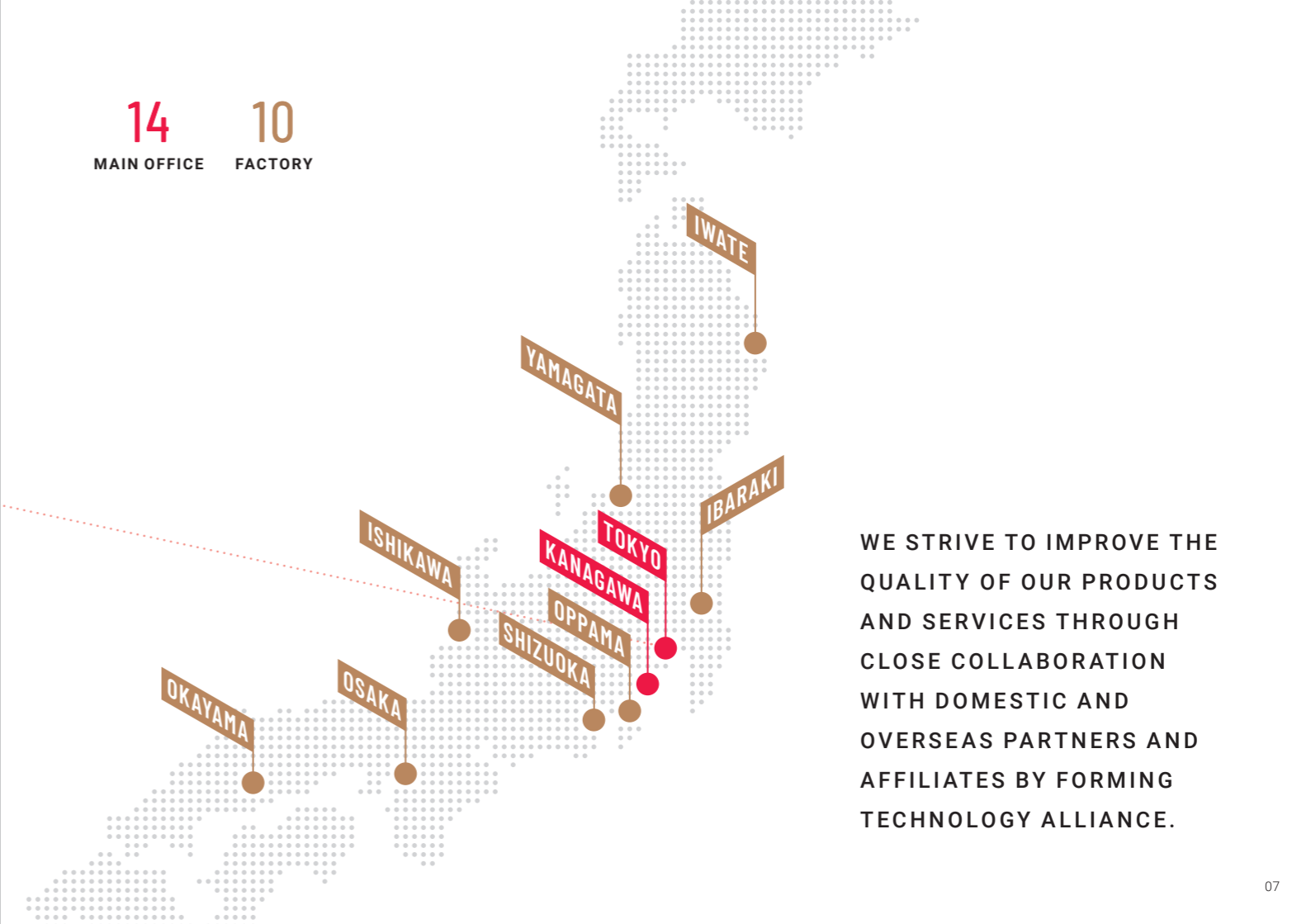

**14** MAIN OFFICE  
**10** FACTORY

WE STRIVE TO IMPROVE THE QUALITY OF OUR PRODUCTS AND SERVICES THROUGH CLOSE COLLABORATION WITH DOMESTIC AND OVERSEAS PARTNERS AND AFFILIATES BY FORMING TECHNOLOGY ALLIANCE.

# SUSTAINABILITY POLICIES AT THE OKAMURA GROUP

THROUGH OUR MISSION AT THE OKAMURA GROUP, "CONTRIBUTE TO SOCIETY BY CREATING ENVIRONMENTS WHERE PEOPLE CAN THRIVE WITH RICH IDEAS AND RELIABLE QUALITY", WE AIM FOR ENHANCED CORPORATE VALUE AND PROVIDING SOLUTIONS TO ISSUES FACING SOCIETY.

## ANSI/BIFMA X5.5 ANSI/BIFMA X5.1

American National Standard  
for Office Furnishings  
• Desk Products



BIFMA's Sustainability  
Certification Program  
for Furniture



Indoor Air Quality  
Certification for Furniture  
and Building Materials

Further Info.



## AWARDS



GERMAN  
DESIGN  
AWARD  
WINNER  
2020



reddot winner 2022



DESIGN  
AWARD  
2022



UNIVERSAL DESIGN  
WINNER  
2022  
EXPERT



BEST YEAR  
AWARD 2021  
EXTERIOR  
DESIGN



HP  
AWARD



GOOD  
DESIGN



ERGONOMIC  
EXCELLENCE  
AWARD



FX  
SHORTLIST  
2020



104th INTERNATIONAL DESIGN EXCELLENCE AWARDS



interior  
innovation  
award  
2019  
Winner



dFA  
MERIT  
AWARD  
2021



GOOD  
DESIGN



JIDA  
DESIGN  
MUSEUM



IAUD  
AWARD  
2016



KIDS  
DESIGN  
AWARD  
2022



ERGONOMIC DESIGN  
ENGINEERING GOOD PRACTICE



JAPAN WOOD DESIGN  
AWARD 2015

## WARRANTY PERIOD

The following cases are excluded from the warranty;

- Due to wear and tear caused by normal use
- Damage to cloth, mesh, etc. due to human factors
- Products customized or modified locally

10  
YEARS

Structural components, including frames, shells, bases, operating mechanisms including adjustable armrest

5  
YEARS

Casters, gas cylinder, adjusters and adjustment levers

2  
YEARS

Coating finish, mesh & fabric, cushions, and armpads

20 YEARS  
OF  
OKAMURA  
WITH  
ITALDESIGN



## Contessa 20<sup>th</sup> Anniversary

Leading furniture manufacturer, Okamura, joined forces with Turin-based design firm, ITALDESIGN in 2000, to create a world class office chair. Two years later, Contessa emerged, an instant classic. Contessa's form celebrates contrast. The sheer, transparent tension of stretched mesh across the seat and back provides an elegant counterpoint to the sleek, industrial weight of the aluminum frame. Iconic and enduring looks, with outstanding ergonomic functionality, have ensured this task chair quickly earned global acclaim. For the past 20 years, Contessa has remained a favorite in office seating.

Special Website



The Industrial Design Division of Italdesign, headquartered in Moncalieri, Torino – Italy, was established in 1981 and today is one of the most renowned and leading organizations in the industrial and transportation design fields on a worldwide level. Acclaimed for its proclivity in all-round functional design, Italdesign's projects range from automobiles to pieces of furniture, from tires to watches and home appliances.



2002 *Contessa*    2004 *Baron*    2010 *Luce*    2012 *Sabrina*    2016 *Contessa II seconda*    2018 *Finora*    2022 *Contessa 20<sup>th</sup> Anniversary*





## OKAMURA MATERIALS



### MESH WITH KAWASHIMA SELKON TEXTILES

Okamura's mesh by Kawashima Selkon Textiles, rooted in Nishijin-ori - a traditional type of weaving unique to Kyoto, Japan, has evolved in various ways design wise. Naturally, everything from material procurement, to mesh construction and chair assembly takes place in Japan. It's this 'Made in Japan' quality that makes our mesh seating so special.



### FABRIC WITH KVADRAT

Okamura and Kvadrat were united by a shared quest to create the highest quality and beautiful designs. Together we will continue to make work environments more creative and pleasing, by elevating the seating to the level of an exquisite, yet hardworking piece of art.

A composite image for the 'Re:net' campaign. The top half shows a fisherman in a yellow raincoat pulling a net full of fish from a boat on the ocean. The bottom half shows a close-up of a blue mesh fabric with a clear plastic bottle lying on it, symbolizing the use of recycled fishing nets. A white text box is overlaid on the top image.

**Re:net**  
**ONE FOR THE OCEANS**  
Marine debris harms the delicate balance of ocean life. Our sustainable textile Re:net holds a benefit greater than its exquisite and subtle beauty. By choosing the product, created from salvaged fishing nets, you will play a part in protecting our oceans and marine life.



### INNOVATING FOR A BETTER WORKPLACE

From concept to completion, Okamura products are brimming with the creative spirit. Even the smallest details push the boundaries of conventional design, so we create something entirely new and wholly unique, again and again. All with the end goal to evolve the workplace, creating more productive, more creative, and happier environments.

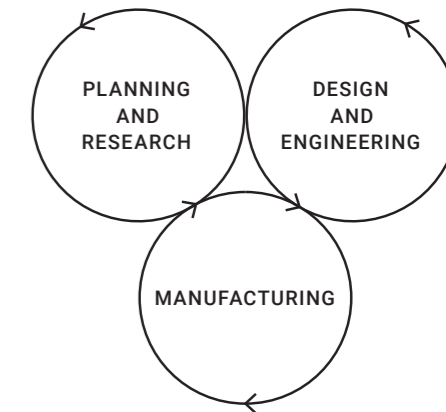

# POSTURE

## EXECUTIVE CHAIR

Legender  
Shibusa  
Contessa II  
Choral

## TASK CHAIR

Sphere  
Finora  
Sabrina Standard  
Sylphy  
Portone Smart  
Rin  
Primp

## MULTI-PURPOSE CHAIR

Plimode  
Lives Work Chair  
Cynara  
e.n.a.  
MC (Marca)  
Runa  
T1  
Repiroue





# Legender

Made in Japan

Legender is the ultimate executive chair. A combination of functionality, class and elegance, drawing upon our expertise in ergonomics and our long tradition of creating beautiful furniture. Soft and supple leather and world class design, for the world's leading executives.

Product Info.

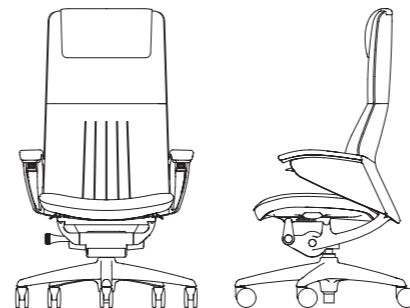

Color



Dimensions

Extra High Back :  
W686 × D575-625 × H1201-1311

High Back :  
W686 × D575-625 × H1051-1161

ANSI/  
BIFMA  
X5.1





# SHIBUSA

## Made in Japan

Simplicity, implicit, modesty, naturalness, everydayness, imperfection, and silence. In these traits, one discovers the Japanese aesthetic philosophy of Shibusu.

Suspended in the balance between simplicity and complexity, restraint and spontaneity, SHIBUSA by Okamura represents understated elegance and quiet confidence.

## Product Info.

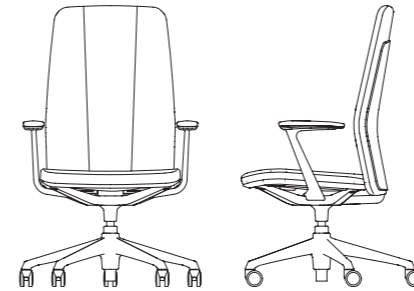

## Color

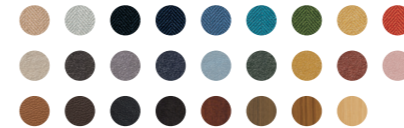

## Dimensions

High Back :  
W650 x D575 x H1050-1160

Mid Back :  
W650 x D556 x H940-1050

ANSI/  
BIFMA  
X5.1





## Contessa II *seconda*

### Made in Japan

Since debuting on the world stage in 2002, the highly regarded Contessa has been reborn.

While the elegant lines of Contessa's original form have been maintained, the chair's functionality has been upgraded to meet the needs of our diverse global customers.

### Product Info.

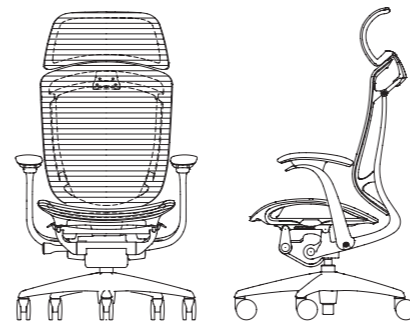

### Color



### Dimensions

Extra High Back :  
W650-702 × D620-670 × H1170-1270

High Back :  
W690 × D570-620 × H980-1080

ANSI/  
BIFMA  
X5.1





# Choral

Made in Japan

Choral's name symbolizes the concept of a "perfectly tuned chair" - ergonomically tuned to your body and aesthetically tuned to the office. This simple approach has achieved a timeless design and dynamic beauty that is harmonized to complement a multitude of office environments.

Product Info.



Color



Dimensions

Extra High Back :  
W660-710 × D577-627 × H1170-1370

High Back :  
W660-710 × D577-627 × H981-1081

ANSI/  
BIFMA  
X5.1





# Sphere

**Made in Japan**

The casual light seating favored in shared settings is only intended for short duration sits. But behaviorally, on their office days, workers still tend to settle in for longer. Even if highly specified task chair is provided, very few workers take the time to make the beneficial micro adjustments, each time they settle in. Sphere has been designed to eliminate this compromise.

**Product Info.**

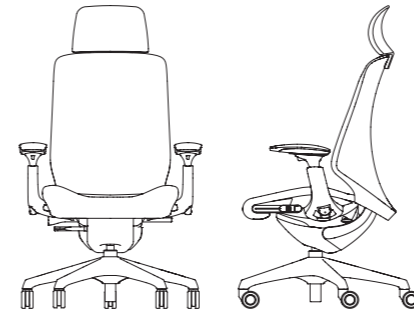

**Color**



**Dimensions**

W700 x D700 x H966-1066

**ANSI/  
BIFMA  
X5.1**





# Finora

Made in Japan

Elevate your work in the uncompromised beauty of lightness. Finora was designed to encapsulate beauty with streamlined thinness and lightness. By applying the design philosophy that is distinctive to the automotive industry, Finora provides the modern worker with a high level of functionality for the ultimate level in comfort in an office chair without sacrificing the esthetic design.

Product Info.

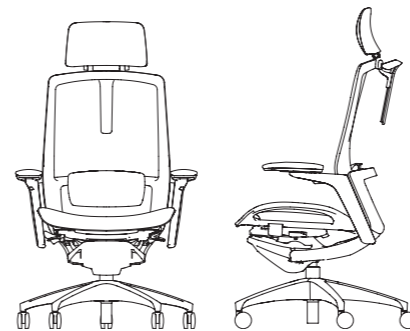

Color



Dimensions

High Back :  
W690-740 × D540-590 × H970-1070

Mid Back :  
W640 × D540-590 × H910-1010

ANSI/  
BIFMA  
X5.1







# Sabrina

Standard

**Made in Japan**

You can see this iconic ring structure not just in back view but from front view through permeable mesh back for which you have ample color variation to choose from.

Welcome to the Sabrina world of the beautiful marriage between state-of-the-art technology and a world-renowned design.

**Product Info.**

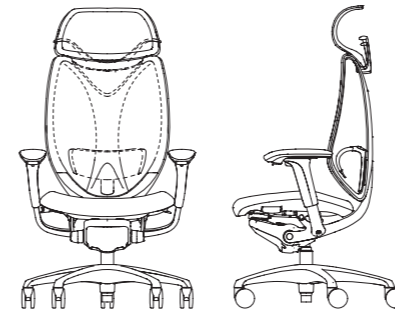

**Color**



**Dimensions**

Extra High Back :  
W695 × D570-620 × H1190-1290

High Back :  
W650 × D570-620 × H1185-1315

**ANSI/  
BIFMA**  
X5.1





# Sylphy

Okamura understands that people's backs are all shaped differently. To accommodate these differences, Sylphy provides superior comfort — as if the backrest were custom-made for you. Sylphy fits every member of your office.

Product Info.



Color



Dimensions

High Back with Headrest :  
W648 × D658-708 × H1153-1283

High Back :  
W642 × D574-624 × H960-1090

ANSI/  
BIFMA  
X5.1





# Portone Smart

Made in China

The union of style and comfort. The pliable frame harmonizes with your movement as the lumbar support comfortably contours the curves of your back. A design born of Okamura's fascination with ergonomics.

Product Info.



Color



Dimensions

Extra High with Headrest :  
W656 x D560-610 x H1130-1300

High Back :  
W656 x D560-610 x H970-1090

ANSI/  
BIFMA  
X5.1





# Rin

Made in Thailand

An ergonomic mesh chair named after the Japanese word which translates to 'a dignified state of being'. Designed based on Okamura's own research into ergonomics, Rin is a chair that provides a comfortable seating experience and helps maintain ideal posture.

Product Info.



Color



Dimensions

High Back with Headrest :  
W650 x D561 x H1190-1290

High Back :  
W650 x D558 x H975-1075

ANSI/  
BIFMA  
X5.1





# Primp

Made in China

The quality of a chair is measured by the level of comfort you'd experience after sitting in it for long periods of time. Primp is a basic chair that supports your back with a soft mesh fabric, giving you nice comfort. Backed up by Okamura's strong DNA in engineering, Primp freshens up the office ambiance with smart design.

Product Info.

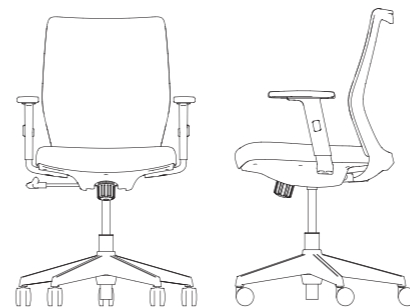

Color



Dimensions

W485 x D540 x H868-988

ANSI/  
BIFMA  
X5.1





# plimode

**Made in Japan**

Plimode helps you maintain optimal posture, leaving you refreshed and invigorated. Admire the attention to quality in every stitch and detail, from the chair's fit to the final finish. Plimode is imbued with 70 years of Okamura craftsmanship and design.

**Product Info.**

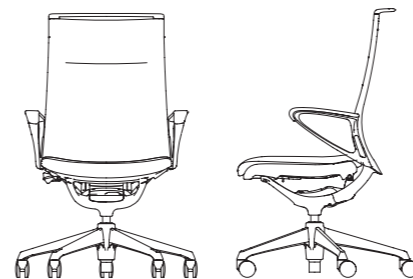

**Color**



**Dimensions**

High Back :  
W605 × D577 × H1000-1110

Mid Back :  
W630 × D573 × H935-1045

**ANSI/  
BIFMA  
X5.1**





# Lives Work Chair

**Made in Japan**

Today's office chairs demand more than functionality. Relaxed, residential-feel spaces create work environments where workers express themselves and thrive. Lives Chairs bring a casual look to the office and are equipped with the state of the art features that employees have come to expect.

**Product Info.**

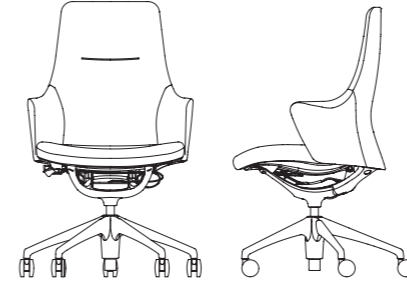

**Color**



**Dimensions**

High Back :  
W582 x D560 x H956-1056

Low Back :  
W582 x D530 x H856-956

**ANSI/  
BIFMA  
X5.1**





# CYNARA

Made in Japan

Experience the impossible lightness and effortless support of Cynara, a task chair that integrates intuitive, responsive functionality with a clean-cut, refined aesthetic to complete any work setting.

Product Info.

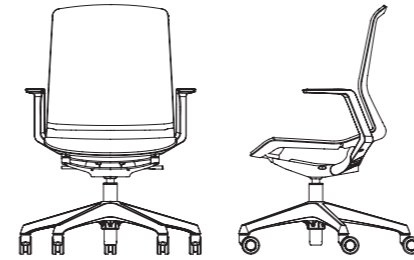

Color



Dimensions

W610 x D500 x H914-1024

ANSI/  
BIFMA  
X5.1







# e.n.a.

**Made in Japan**

Targeting co-creation spaces that require stylish solutions, e.n.a. was born from our collaboration with ITO Design where the goal was to create a chair that could represent Okamura's existing lineup.

Product Info.

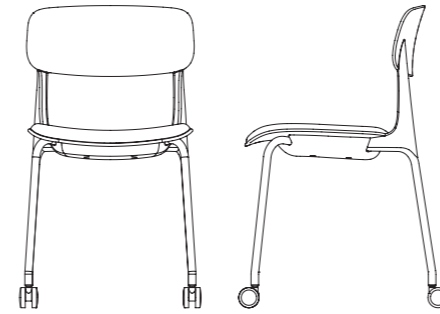

Color

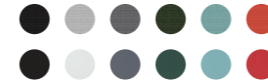

Dimensions

W424 x D529 x H779

ANSI/  
BIFMA  
X5.1



# MC

Made in Japan

Sharp frame, supple sitting comfort, excellent storage capacity. Marca, the high-quality and delicate design along with human-friendly functions provides new value to the meeting scene.

## Color



## Dimensions

W590 × D570 × H820

## Product Info.



ANSI/  
BIFMA  
X5.1



# Runa

Made in Japan

Simplistic design that embodies the functional needs of versatile office environment. "Runa" offers a comprehensive seating collection with a wide variety of colors and finishes. When you need freedom to think creatively and want those big ideas, "Runa" gives you that freedom and support to succeed.

## Color



## Dimensions

Basic :  
W562 × D560 × H837

## Product Info.



ANSI/  
BIFMA  
X5.1





# T1

**Made in Japan**

Simple yet chic and comfortable, T1 is an attractive choice for every meeting. Its beautiful design and comfortable functionality unites a range of possibilities. With a cantilever structure and mesh backrest, T1 conforms to the shape of your body. Comfort and style truly come together in the T1.

**Product Info.**



**Color**



**Dimensions**

W576 × D628 × H867





# repiroue

Made in Japan

Okamura recommends five postures for increased office productivity and efficiency. Among them is the perching posture, a perfect combination of standing and sitting, which is suitable for a standing meeting or a touchdown. Our perching stool, repiroue was brought to life with the intention of making the perching posture more accessible in the office environment.

Product Info.

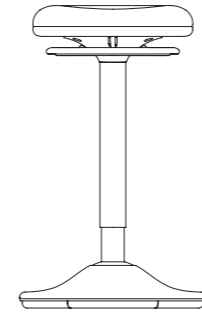

Color

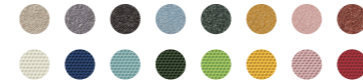

Dimensions

Φ350 × H565-815

ANSI/  
BIFMA  
X5.1



# WORK STATION

Traverse

Traverse Satellite

Oree

Workflex **NEW**

SW (Swift)

Soliste

Risefit III

Flaptor-A





# traverse

Made in Japan

In today's workplace, conference rooms are challenged with shrinking size as well as the need to adapt to evolving technologies. Traverse is a collection of two conference tables defined by narrow contours that broaden office space, bringing people together beautifully.

Product Info.

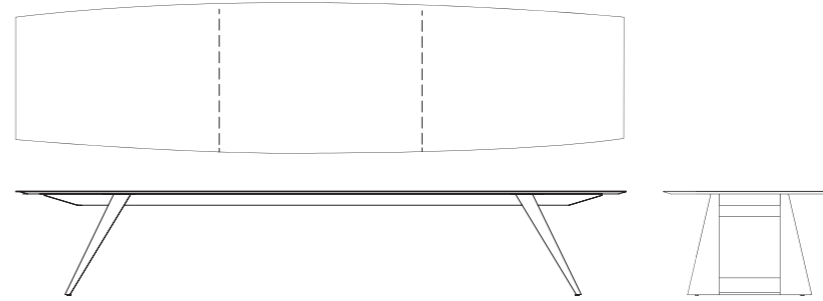

Color



ANSI/  
BIFMA  
X5.5





# traverse satellite

Made in Japan

Conference rooms and the tables around which we gather are changing. They have become a gathering place for collaboration, from informal to formal, small to large groups. The newest member of the Traverse table collection —traverse satellite — offers Okamura's incomparable attention to detail and engineering-forward design, at a size appropriate for smaller conference rooms and offices.

Product Info.

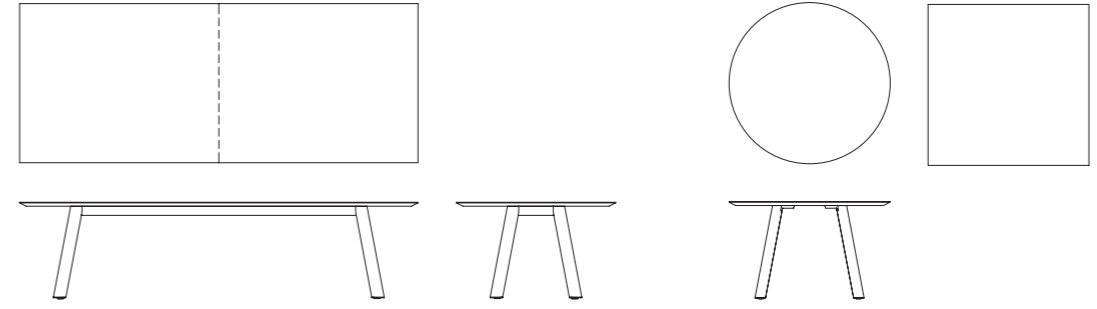

Color



ANSI/  
BIFMA  
X5.5





# OREE

Made in Thailand

OREE signifies a point that infuses simplicity and strength while drawing inspiration from Japanese origami. With origins in Japan, origami art combines defined shapes and edges, to bring forth artistic structures. Fusing Okamura's skilled sheet metal technology with folds of thin sheet metal creates a beautiful and strong foundation.

Product Info.

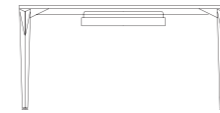
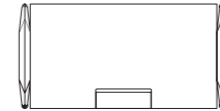
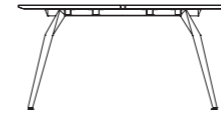
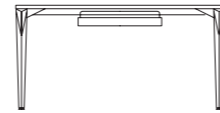
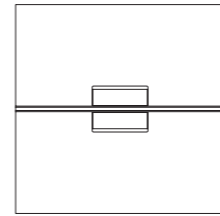

Color

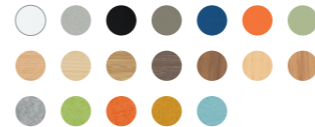

ANSI/  
BIFMA  
X5.5







# Workflex

Made in Thailand

The traditional fixed location work style in which each worker has their own desk has been replaced by a new style of working where workers are free to change locations depending on the nature of the task they are working on. As the name suggests, Workflex is a desk system that brings flexibility to the way you work.

Product Info.

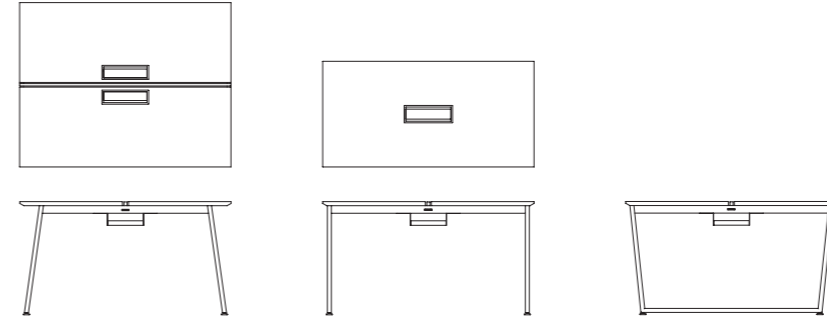

Color



ANSI/  
BIFMA  
X5.5





# SW

Made in Japan

Move the surface of the desk up or down quickly and with ease, creating the optimum positioning for the worker when it's needed. With full focus on freed movement, comfort and safety, this flexible SW is a fusion of design and functionality.

### Color

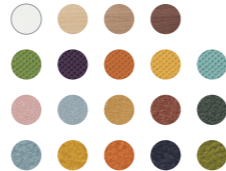

### Product Info.



ANSI/  
BIFMA  
X5.5



# SOLISTE

Made in Thailand

SOLISTE is a new concept in desks developed for the office of the future. Its simple design, with narrow top and elegant, slim legs, makes it beautiful when used alone, but it can also be used in pairs without feeling overwhelming, creating an open and sophisticated working space.

### Color



### Product Info.





# Risefit III

Made in Japan

Risefit III is a versatile supplementary work table that can be used in any part of your company's office, lobby, or lounge. Its height can be continually readjusted to meet the needs of any particular user at any time, whether sitting or standing.

Color



Product Info.



ANSI/  
BIFMA  
X5.5



# FLAPTOR-A

Made in Thailand

Folding table Flaptor A is designed as a parallel nesting table. It realizes space saving and beautiful storing. The square pipe legs and frame support the table's luxurious design, stability and durability.

Color



Product Info.



## LOUNGE & MODULAR

Nagare

Phlox

Lives Work Lounge Chair

Lives Pouf

Drape

Lives Shelf

Sprint





# NAGARE

Made in Japan

Nagare, which means 'flow' in Japanese, is a new collection of lounge furniture that responds to the way we work today. Nagare consists of two distinct families – NAGARE Lounge and NAGARE Platform – each element possesses a sculptural quality that makes a bold aesthetic statement, while also being highly functional. This new collection has been carefully designed to help us work more effectively wherever work might happen.

Product Info.

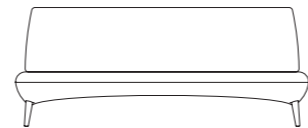
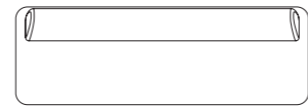
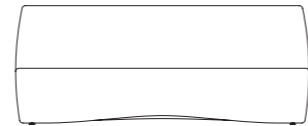
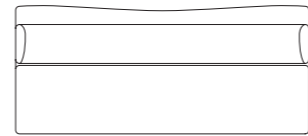

Color

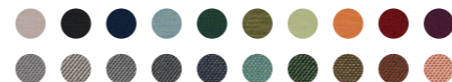



# Phlox

Made in Japan

Nature is at the heart of this family of collaborative chairs and tables, that beckon colleagues to connect with comfort and ease. Beautiful, curved forms will soften the work space and invite a flow of creative energy. Spill into organic break-out settings, where easy and natural interactions will follow. Inspired by the fragrance and fascinating petals of the night phlox flower, the range captures both the vitality and calming influence of nature. Phlox Collection was designed with circularity in mind, ensuring a gentle footprint. Ideas flow, naturally.

Product Info.

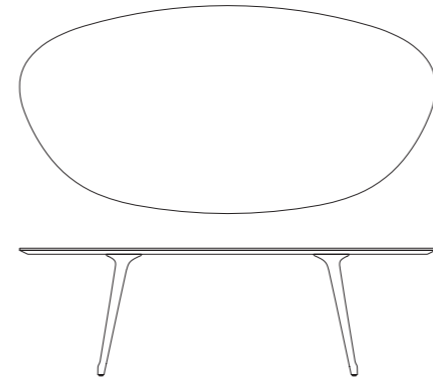

Color

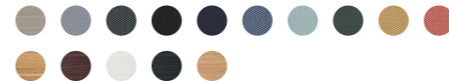

ANSI/  
BIFMA  
X5.1/X5.5





# Lives Work Lounge Chair

Made in Japan

Today's office chairs demand more than functionality. Relaxed, residential-feel spaces create work environments where workers express themselves and thrive.

Lives Work Lounge bring a casual look to the office and are equipped with the state of the art features that employees have come to expect.

Color



Product Info.



ANSI/  
BIFMA  
X5.1



# Lives Pouf

Made in Japan

Lives Pouf is designed to encourage creative thinking and to support informal ways of working and collaboration in the shared areas of the workplace – such as cafes and touch down points, break-out spaces, co-working environments. Its softness and warmth allow you to create a place to repose within the information storm of our times.

Color



Product Info.





# drape

Made in Thailand

drape is a minimal-sized pod with sound-absorbing capability. It takes up as little as four carpet tiles to build and transform open offices into a hub of concentration. The outer side of the two-toned panels are colored with brighter hues to uplift the office, while the inside panels are covered with a calming gray tone.

Color

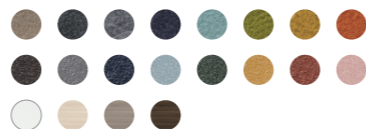

Product Info.



# Lives Shelf

Made in Thailand

A shelf with a wide range of usability and configuration, extending the versatility of a display shelf. By reconsidering the structure of the frame and shelf board, it has evolved into a minimalistic design. Not only can it partition the space, but it also can allow or block the visual field with a combination of panels.

Color



Product Info.







# SPRINT

Made in Japan

Don't just choose a space that matches your working style - create it. In conventional offices, workers all use the same meeting rooms. But "workstyle reforms" and working from home policies have significantly transformed the way we work. As workers' values become more diverse, what should the office of the future look like? Okamura believes that workers creating ideas in person through teamwork will define the next era of office work.

Product Info.

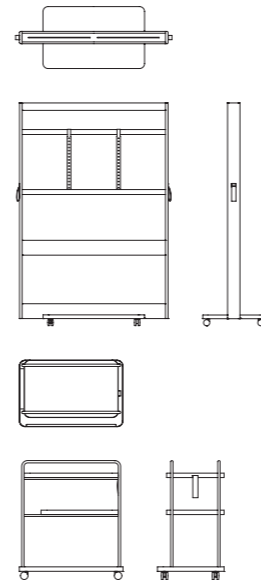

Color





In offices where workers carry out diverse tasks, it is best if individuals can freely choose the environment optimally suited to their particular needs. Okamura offers proposals that create spaces accommodating of each individual's characteristics and circumstances to maximize their capabilities.



## MATTEL OFFICES

**Location :** Warsaw, Poland

**Industry :** Entertainment

**Completion Year :** 2024

### About the Project :

Project was run by BitCreative architects. The most challenging was to find conference chairs which will be corresponding in colors to the „Barbie” and „Fisher-Price” brands - the most representative for Mattel. The customer's expectations were to find comfortable chairs, which will be consistent with the branding colors but will not dominate in the conference rooms.

### Products :



Plimode



## LARGE BANK

**Location :** London, UK

**Industry :** Bank

**Completion Year :** 2022

### About the Project :

The project is for the new normal era. It was to add more ABW based furniture into the office to aid staff on their return to the office after the pandemic.

### Products :



Lives  
Work Chair



Lives  
Café Chair

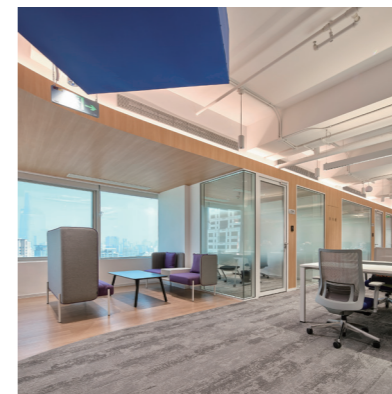

## LAWSON (CHINA) HOLDINGS CO.,LTD

**Location :** Shanghai, China

**Industry :** Retail

**Completion Year :** 2022

### About the Project :

The office renovation project aims to accommodate more staff and a new work style. The new office has a free-address system, exposed ceilings, and indirect lighting to create a brighter and open environment. Curved lines and the color blue are used as interior accents to foster individuality and creativity.

### Products :



Contessa II



Portone



Plimode  
Light



## DOLE ASIA HOLDINGS PTE., LTD.

**Location :** Singapore

**Industry :** Food Industry

**Completion Year :** 2022

### About the Project :

This office design is inspired by the "Dole Banana Plantation" in Mindanao, Philippines. It features a ceiling design representing the sky and a curvy walkway mimicking the plantation's trail. The interior finish uses natural materials to create a farm-like atmosphere, with earthy hues as the base color and vibrant colors representing fruits and Dole's corporate color.

### Products :

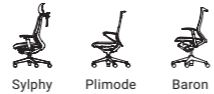

Sylphy Plimode Baron



Precede Lives Work Table Flaptor

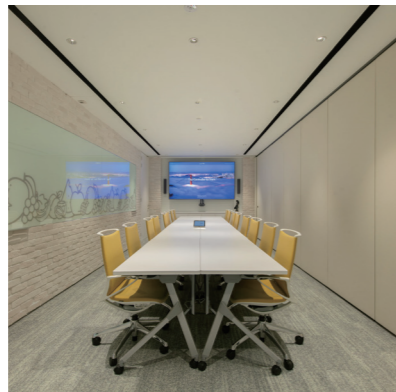

## PANASONIC SOLUTIONS (THAILAND HEAD OFFICE)

**Location :** Bangkok, Thailand

**Industry :** Manufacturer

**Completion Year :** 2022

### About the Project :

This project aim to integrate each Panasonic Group companies in Thailand into one office. The office has a free space in the center to encourage the interaction of the staff from each group company, provide a comfortable workplace for workers.

### Products :



Manifold-A Rin Personal Locker Drape

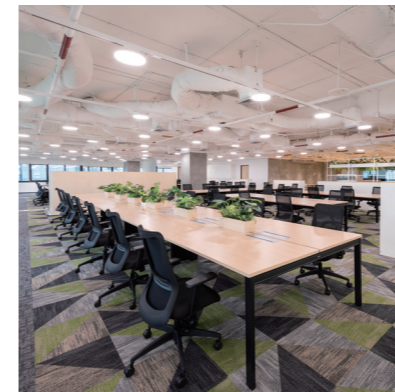



## GENERAL TRADING COMPANY

**Location :** Kuala Lumpur, Malaysia  
**Industry :** General Trading Company  
**Completion Year :** 2022

### About the Project :

Located in Kuala Lumpur, the Japanese Multinational Corporation integrated the company's values, vision, mission, and principles into the workplace design. A sense of unity and cohesion was fostered, reinforcing the company culture and employees' connection to organizational goals.

### Products :

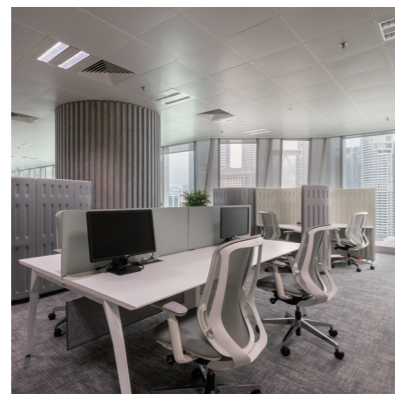

## MITSUBISHI CORPORATION (JAKARTA REPRESENTATIVE OFFICE)

**Location :** Jakarta, Indonesia  
**Industry :** Trading  
**Completion Year :** 2022

### About the Project :

Right sizing project influenced by covid 19. In order to adjust new normal, communication area and personal online meeting rooms are installed. Uses can feel Indonesian aesthetic because Batik, traditional Indonesian pattern, is used in interior design.

### Products :

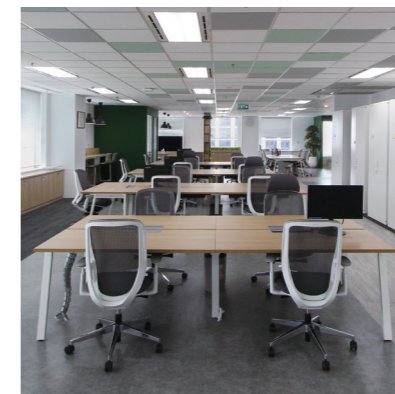
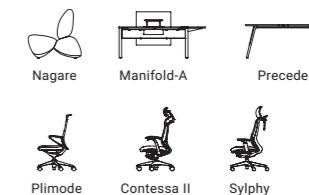



## KEYENCE VIETNAM

**Location :** Hanoi, Vietnam

**Industry :** Electronics

**Completion Year :** 2023

**Design :** T.S.I Vietnam Co., Ltd

### About the Project :

Keyence supplies sensors, measuring systems, laser marking machines, microscopes, and machine vision systems worldwide, they lead the way in factory automation. Red and black are the corporate color that they cherish it. Our products give essence to their logic and support their workstyle.

### Products :



Contessa II Sylphy Plimode Repairou 81T2



## C.P. SEED

**Location :** Dong Nai City, Vietnam

**Industry :** Agriculture, Financial

**Completion Year :** 2023

### About the Project :

C.P. (Charoen Pokphand) is a multinational corporation and one of Thailand's strongest group in the fields of industry, agriculture and finance. In the field of agriculture, C.P Group is the largest corporation in Thailand and C.P. Products are popular all over the country and around the world.

### Products :



Oree Contessa II Portone Smart

