

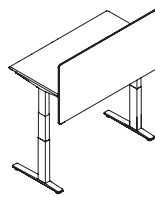

## Statement of Line

### Work table | P2-12

#### Free standing type → P4

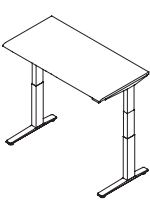

With front screen

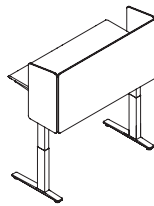

With front and side screens

#### L-shaped type → P5

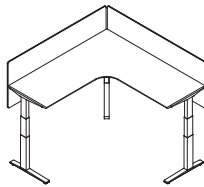
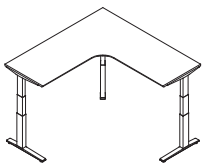

With front screen

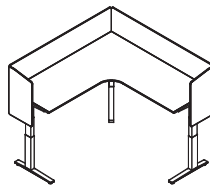

With front and side screens

#### Bench type → P6

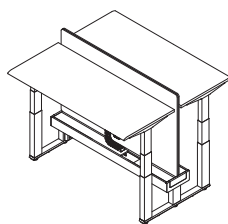
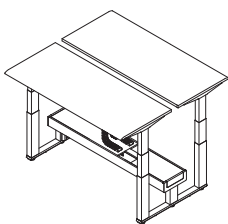

With fixed screen

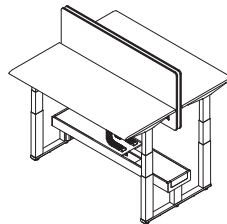

With individual screens

### Conference table | P13-14

#### 2-column table

Wide: 82 3/4", 94 1/2"

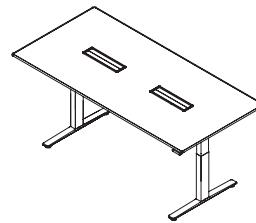

With cable opening

Wide: 70 7/8"

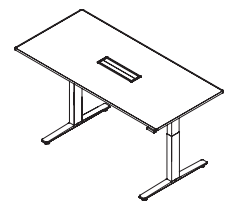

Wide: 82 3/4", 94 1/2"

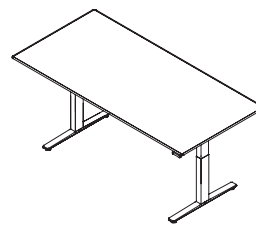

Without cable opening

Wide: 70 7/8"

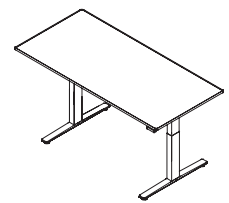

#### 4-column table – wide type

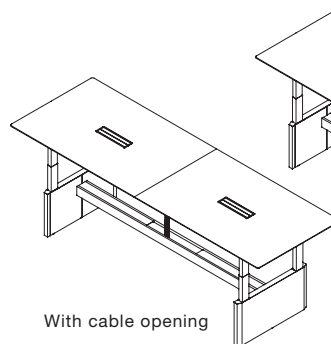

With cable opening

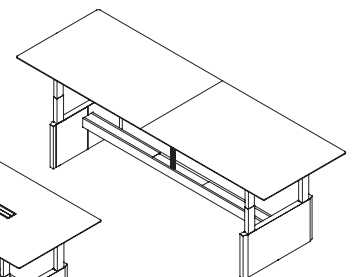

Without cable opening

### Basic Table Specifications

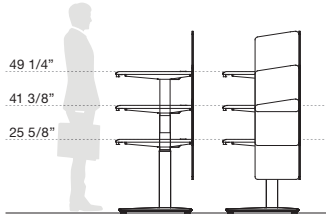

You can adjust the table top height within the range from 25 5/8" to 49 1/4".

\*With a safety reverse function that moves the desk approximately 1 inch backward (approximately 1 1/8" when the desk is moved slowly) immediately when the desk hits an obstacle as standard  
 \*Rated voltage: 120V, rated frequency: 60Hz  
 \*Rated power consumption: free standing type: 300W L-shaped type: 450W bench type: 600W (300W per seat)

When laying out tables, be sure to leave the amount of space indicated below between them to ensure safety.

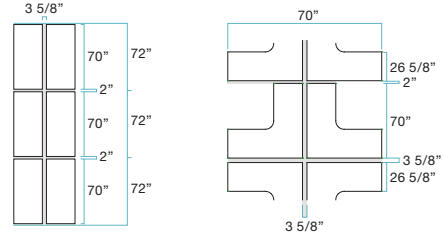

Free standing type  
Bench type

L-shaped type

### Customizable Type

#### Control panel



The lever type control panels allow you to lift or lower the desk more intuitively. You can select from two versions: the one with indicator including a height display and a memory function which allows you to save your three preferred heights, the simpler one without indicator which only includes a lifting and lowering function.

#### Table top edge



Sloped edge

Knife edge

A sloped edge with a smooth, round surface that remains comfortable even if you lean on it with your arms. You can also select a more linear and sharper knife edge.

### Color

#### Leg color



ZF97 White  
ZF96 Silver  
ZF95 Black

#### Table top color \*Anti-fingerprint laminate



MG07 White  
MK17 Neo Wood Light  
MK18 Neo Wood Medium  
MK19 Neo Wood Dark  
MX51\* Prize Wood Light  
MX52\* Prize Wood Medium  
MX53\* Prize Wood Dark



MY31



MY32



MY23



MY14

### Desk combination code

Combination code	Part name / code		Combination code	Part name / code		Combination code	Part name / code	
	Table top	Body		Table top	Body		Table top	Body
MY31 (White)	MG99	MG07 (Laminate: White) G939 (Edge: White)	MY21 (White)	MG99	MG07 (Laminate: White) G939 (Edge: White)	MY11 (White)	MG99	MG07 (Laminate: White) G939 (Edge: White)
MY32 (Neo Wood Light)	MK37	MK17 (Laminate: Neo Wood Light) G947 (Edge: Neo Wood Light)	MY22 (Neo Wood Light)	MK37	MK17 (Laminate: Neo Wood Light) G947 (Edge: Neo Wood Light)	MY12 (Neo Wood Light)	MK37	MK17 (Laminate: Neo Wood Light) G947 (Edge: Neo Wood Light)
MY33 (Neo Wood Medium)	MK38	MK18 (Laminate: Neo Wood Medium) G948 (Edge: Neo Wood Medium)	MY23 (Neo Wood Medium)	MK38	MK18 (Laminate: Neo Wood Medium) G948 (Edge: Neo Wood Medium)	MY13 (Neo Wood Medium)	MK38	MK18 (Laminate: Neo Wood Medium) G948 (Edge: Neo Wood Medium)
MY34 (Neo Wood Dark)	MK39	MK19 (Laminate: Neo Wood Dark) G949 (Edge: Neo Wood Dark)	MY24 (Neo Wood Dark)	MK39	MK19 (Laminate: Neo Wood Dark) G949 (Edge: Neo Wood Dark)	MY14 (Neo Wood Dark)	MK39	MK19 (Laminate: Neo Wood Dark) G949 (Edge: Neo Wood Dark)
MBL2 (Prize Wood Light)	MX61	MX51 (Laminate: Prize Wood Light) GE21 (Edge: Prize Wood Light)	MBK2 (Prize Wood Light)	MX61	MX51 (Laminate: Prize Wood Light) GE21 (Edge: Prize Wood Light)	MBJ2 (Prize Wood Light)	MX61	MX51 (Laminate: Prize Wood Light) GE21 (Edge: Prize Wood Light)
MBL3 (Prize Wood Medium)	MX62	MX52 (Laminate: Prize Wood Medium) GE22 (Edge: Prize Wood Medium)	MBK3 (Prize Wood Medium)	MX62	MX52 (Laminate: Prize Wood Medium) GE22 (Edge: Prize Wood Medium)	MBJ3 (Prize Wood Medium)	MX62	MX52 (Laminate: Prize Wood Medium) GE22 (Edge: Prize Wood Medium)
MBL4 (Prize Wood Dark)	MX63	MX53 (Laminate: Prize Wood Dark) GE23 (Edge: Prize Wood Dark)	MBK4 (Prize Wood Dark)	MX63	MX53 (Laminate: Prize Wood Dark) GE23 (Edge: Prize Wood Dark)	MBJ4 (Prize Wood Dark)	MX63	MX53 (Laminate: Prize Wood Dark) GE23 (Edge: Prize Wood Dark)

**Color**

■ Screen color

Free standing type, L-shaped type Front and side screens, two-tone fabric combination. \*Front and side screens only

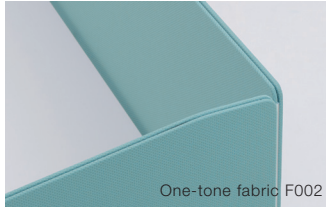

Combination code	Fabric / outside	Fabric / inside
F02B	F002 (Sage)	 <b>F024 Vanilla</b>
F07B	F007 (Huckleberry)	
F10B	F010 (Pumpkin)	
F13B	F013 (Blackberry)	
F15B	F015 (Grape)	
F25B	F025 (Mushroom)	
F27B	F027 (Chamomile)	
F29B	F029 (Indigo)	

Free standing type, L-shaped type Front and side screens (one-tone fabric screen)

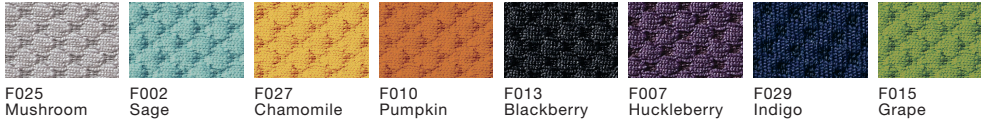

**Dimple**



**Interlock**



Bench type Fixed screen Color combination code

Combination code	Fabric	Body	Combination code	Fabric	Body	Combination code	Fabric	Body
FZT1	F002 (Sage)	 <b>ZF97 (White)</b>	FZS1	F002 (Sage)	 <b>ZF96 (Silver)</b>	FZR1	F002 (Sage)	 <b>ZF95 (Black)</b>
FZT2	F007 (Huckleberry)		FZS2	F007 (Huckleberry)		FZR2	F007 (Huckleberry)	
FZT3	F010 (Pumpkin)		FZS3	F010 (Pumpkin)		FZR3	F010 (Pumpkin)	
FZT4	F013 (Blackberry)		FZS4	F013 (Blackberry)		FZR4	F013 (Blackberry)	
FZT5	F015 (Grape)		FZS5	F015 (Grape)		FZR5	F015 (Grape)	
FZT6	F025 (Mushroom)		FZS6	F025 (Mushroom)		FZR6	F025 (Mushroom)	
FZT7	F027 (Chamomile)		FZS7	F027 (Chamomile)		FZR7	F027 (Chamomile)	
FZT8	F029 (Indigo)		FZS8	F029 (Indigo)		FZR8	F029 (Indigo)	
FKR1	FXT1 (gray)		FKS1	FXT1 (gray)		FKT1	FXT1 (gray)	
FKR2	FXT2 (beige)	FKS2	FXT2 (beige)	FKT2	FXT2 (beige)			
FKR3	FXT3 (dark brown)	FKS3	FXT3 (dark brown)	FKT3	FXT3 (dark brown)			
FKR4	FXT4 (indigo)	FKS4	FXT4 (indigo)	FKT4	FXT4 (indigo)			
FKR5	FXT5 (dark green)	FKS5	FXT5 (dark green)	FKT5	FXT5 (dark green)			
FKR6	FXT6 (terracotta)	FKS6	FXT6 (terracotta)	FKT6	FXT6 (terracotta)			
FKR7	FXT7 (yellow)	FKS7	FXT7 (yellow)	FKT7	FXT7 (yellow)			
FKR8	FXT8 (pale pink)	FKS8	FXT8 (pale pink)	FKT8	FXT8 (pale pink)			
FKR9	FXT9 (sage)	FKS9	FXT9 (sage)	FKT9	FXT9 (sage)			

Free Standing Type

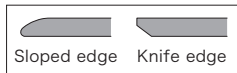
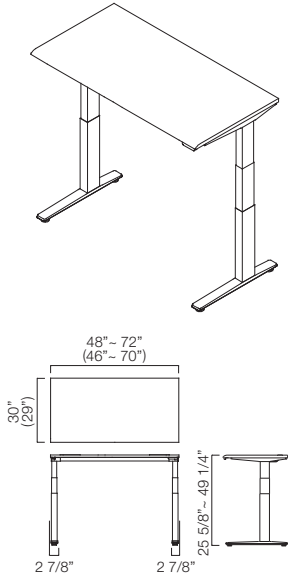

\*Rated power consumption: 300W

■ Table

Control panel	W	D	H	Sloped edge	Knife edge	
				Item code	Item code	
Lever type	with indicator	30"(29")	49 1/4" 25 5/8"	72"(70")	<b>3W20AF-MY</b> <input type="checkbox"/>	<b>3W20FF-MY</b> <input type="checkbox"/>
				66"(64")	<b>3W20AG-MY</b> <input type="checkbox"/>	<b>3W20FG-MY</b> <input type="checkbox"/>
				60"(58")	<b>3W20AH-MY</b> <input type="checkbox"/>	<b>3W20FH-MY</b> <input type="checkbox"/>
				54"(52")	<b>3W20AJ-MY</b> <input type="checkbox"/>	<b>3W20FJ-MY</b> <input type="checkbox"/>
				48"(46")	<b>3W20AK-MY</b> <input type="checkbox"/>	<b>3W20FK-MY</b> <input type="checkbox"/>
	without indicator	30"(29")	49 1/4" 25 5/8"	72"(70")	<b>3W20BF-MY</b> <input type="checkbox"/>	<b>3W20GF-MY</b> <input type="checkbox"/>
				66"(64")	<b>3W20BG-MY</b> <input type="checkbox"/>	<b>3W20GG-MY</b> <input type="checkbox"/>
				60"(58")	<b>3W20BH-MY</b> <input type="checkbox"/>	<b>3W20GH-MY</b> <input type="checkbox"/>
				54"(52")	<b>3W20BJ-MY</b> <input type="checkbox"/>	<b>3W20GJ-MY</b> <input type="checkbox"/>
				48"(46")	<b>3W20BK-MY</b> <input type="checkbox"/>	<b>3W20GK-MY</b> <input type="checkbox"/>

■ Screen (optional)

Type	Front				Front and sides			
	W	H	T	Item code	W	H	T	Item code
17 3/4" Top surface	70"	31 7/8"	0.6"	<b>3W61AA-F</b> <input type="checkbox"/>	70"	31 7/8"	0.6"	<b>3W60AA-F</b> <input type="checkbox"/>
	64"			<b>3W61AB-F</b> <input type="checkbox"/>	64"			<b>3W60AB-F</b> <input type="checkbox"/>
	58"			<b>3W61AC-F</b> <input type="checkbox"/>	58"			<b>3W60AC-F</b> <input type="checkbox"/>
	52"			<b>3W61AD-F</b> <input type="checkbox"/>	52"			<b>3W60AD-F</b> <input type="checkbox"/>
	46"			<b>3W61AE-F</b> <input type="checkbox"/>	46"			<b>3W60AE-F</b> <input type="checkbox"/>
13 3/4" Top surface	70"	28"	0.6"	<b>3W61BA-F</b> <input type="checkbox"/>	70"	28"	0.6"	<b>3W60BA-F</b> <input type="checkbox"/>
	64"			<b>3W61BB-F</b> <input type="checkbox"/>	64"			<b>3W60BB-F</b> <input type="checkbox"/>
	58"			<b>3W61BC-F</b> <input type="checkbox"/>	58"			<b>3W60BC-F</b> <input type="checkbox"/>
	52"			<b>3W61BD-F</b> <input type="checkbox"/>	52"			<b>3W60BD-F</b> <input type="checkbox"/>
	46"			<b>3W61BE-F</b> <input type="checkbox"/>	46"			<b>3W60BE-F</b> <input type="checkbox"/>

■ Clamp-free zone dimensions

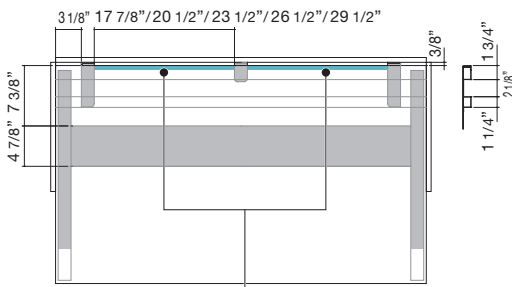

Area where clamping is possible with screen.

■ Required items and options

Item	Required / Option	Notes
Table	Required	
Screen	Option	Select according to the type of desk.
Cable guard	Option	Select single or double according to the cable capacity.
Cable tray (large capacity type)	Option	Select according to the type of desk if large capacity needed.
Opposite table connector	Required depending on the conditions	Required when using an opposing layout.
Desktop power unit	Option	
Pedestal	Option	

● The dimensions are indicated in inch.

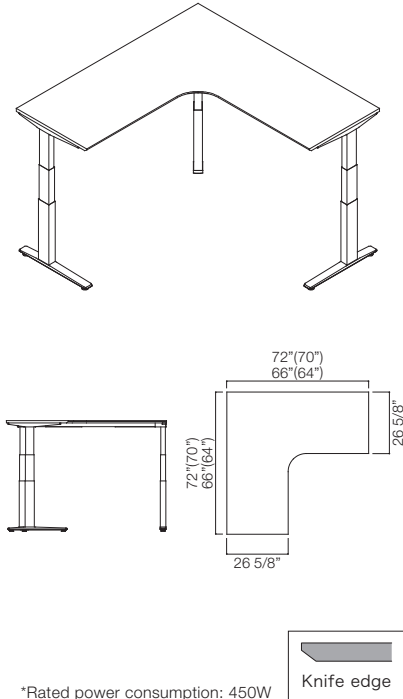

L-shaped Type



\*Rated power consumption: 450W

Knife edge

■ Table

Control panel		W	D	H	Item code
Lever type	with indicator	72"×72"(70"×70")	26 5/8"	49 1/4"	<b>3W23PN-MY</b> □□
		66"×66"(64"×64")		25 5/8"	<b>3W23PR-MY</b> □□
	without indicator	72"×72"(70"×70")	26 5/8"	25 5/8"	<b>3W23PS-MY</b> □□
		66"×66"(64"×64")			<b>3W23PT-MY</b> □□

■ Screen (optional)

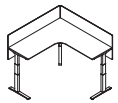
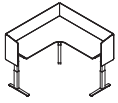
	Front			Front and sides				
								
	28" / 31 7/8"	62 1/4" / 70 1/8"	26 5/8" / 31 7/8"	0.6" / 16 1/4"	28" / 31 7/8"	62 3/4" / 70 5/8"	26 5/8" / 31 7/8"	
Type	W	H	T	Item code	W	H	T	Item code
17 3/4" Top surface	70"	31 7/8"	0.6"	<b>3W61PJ-F</b> □□□	70"	31 7/8"	0.6"	<b>3W60PJ-F</b> □□□
	64"			<b>3W61PK-F</b> □□□	64"			<b>3W60PK-F</b> □□□
13 3/4" Top surface	70"	28"	0.6"	<b>3W61PL-F</b> □□□	70"	28"	0.6"	<b>3W60PL-F</b> □□□
	64"			<b>3W61PM-F</b> □□□	64"			<b>3W60PM-F</b> □□□

■ Required items and options

Item	Required / Option	Notes
Table	Required	
Screen	Option	Select according to the type of desk.
Cable guard	Option	Select single or double according to the cable capacity.
Cable tray (large capacity type)	Option	Select according to the type of desk if large capacity needed.
Opposite table connector	Required depending on the conditions	Required when using an opposing layout.
Desktop power unit	Option	
Pedestal	Option	

### Bench Type

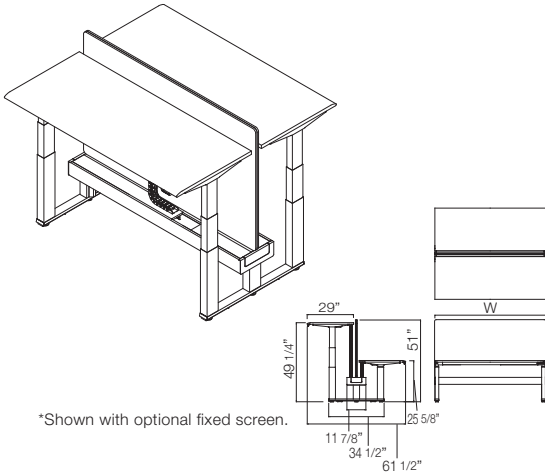

\*Rated power consumption: 600W (300W per seat)

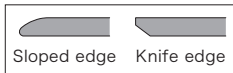

#### Fixed screen (optional)

W	H	T	Item code
70"	51"	1"	<b>3W4J5P-FZ</b> □ □
64"			<b>3W4J6P-FZ</b> □ □
58"			<b>3W4J7P-FZ</b> □ □
52"			<b>3W4J8P-FZ</b> □ □
46"			<b>3W4J9P-FZ</b> □ □

#### Table

Control panel	W	D	H	Sloped edge	Knife edge
				Item code	Item code
Lever type	with indicator	61 1/2"	49 1/4" ± 25 5/8"	<b>3W22AF-MY</b> □ □	<b>3W22FF-MY</b> □ □
				<b>3W22AG-MY</b> □ □	<b>3W22FG-MY</b> □ □
				<b>3W22AH-MY</b> □ □	<b>3W22FH-MY</b> □ □
				<b>3W22AJ-MY</b> □ □	<b>3W22FJ-MY</b> □ □
	without indicator	61 1/2"	49 1/4" ± 25 5/8"	<b>3W22AK-MY</b> □ □	<b>3W22FK-MY</b> □ □
				<b>3W22BF-MY</b> □ □	<b>3W22GF-MY</b> □ □
				<b>3W22BG-MY</b> □ □	<b>3W22GG-MY</b> □ □
				<b>3W22BH-MY</b> □ □	<b>3W22GH-MY</b> □ □
				<b>3W22BJ-MY</b> □ □	<b>3W22GJ-MY</b> □ □
				<b>3W22BK-MY</b> □ □	<b>3W22GK-MY</b> □ □

\*With standard cable guards (two pieces)

#### Individual screen (optional)

Type	W	H	T	Item code	W	H	T	Item code
17 3/4" Top surface	70"	27 7/8"	0.6"	<b>3W61GA-F</b> □ □ □	70"	27 7/8"	0.6"	<b>3W60GA-F</b> □ □ □
	64"			<b>3W61GB-F</b> □ □ □	64"			<b>3W60GB-F</b> □ □ □
	58"			<b>3W61GC-F</b> □ □ □	58"			<b>3W60GC-F</b> □ □ □
	52"			<b>3W61GD-F</b> □ □ □	52"			<b>3W60GD-F</b> □ □ □
	46"			<b>3W61GE-F</b> □ □ □	46"			<b>3W60GE-F</b> □ □ □
13 3/4" Top surface	70"	24"	0.6"	<b>3W61HA-F</b> □ □ □	70"	24"	0.6"	<b>3W60HA-F</b> □ □ □
	64"			<b>3W61HB-F</b> □ □ □	64"			<b>3W60HB-F</b> □ □ □
	58"			<b>3W61HC-F</b> □ □ □	58"			<b>3W60HC-F</b> □ □ □
	52"			<b>3W61HD-F</b> □ □ □	52"			<b>3W60HD-F</b> □ □ □
	46"			<b>3W61HE-F</b> □ □ □	46"			<b>3W60HE-F</b> □ □ □

\*Individual screen and fixed screen cannot be used together.

#### End cover (optional)

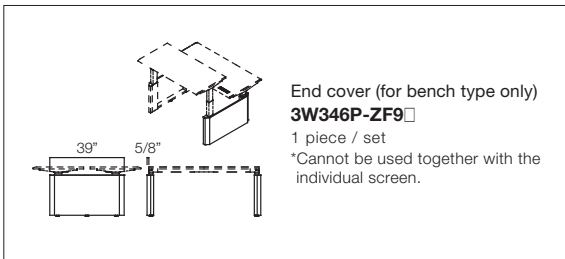

#### Required items and options

Item	Required / Option	Option
Table	Required	
Screen	Option	Select according to the type of desk. Only one can be selected.
End cover	Option	
Power source cable : Module kit	Required	Select one set for each desk according to the type of desk.
Power source cable : Receptacle	Required	Select a total of four for each desk according to the electrical circuit.
Power source cable : Power infeed	Required	Select one each according to the length of the required cable (from the floor to the starting position).
Wiring duct cover	Required	Select according to use of a center panel and type of desk.
Cable tray (large capacity type)	Option	Select according to the type of desk if large capacity needed.
Desktop power unit	Option	
Pedestal	Option	

**Power Source Cable**

**(1) Module kit for each width**

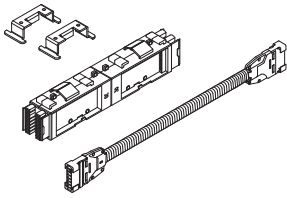

Bench W	Item code
72"(70")	<b>3P51AA-Y647</b>
66"(64")	<b>3P51AB-Y647</b>
60"(58")	<b>3P51AC-Y647</b>
54"(52")	<b>3P51AD-Y647</b>
48"(46")	<b>3P51AE-Y647</b>

\*Select according to the bench width.  
\*Order one set for each bench set.

**(2) Duplex Receptacle (15 Amp)**

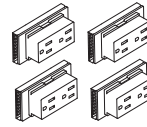

Circuit	Item code
1	<b>3P11UP-Y□□□</b>
2	<b>3P11VP-Y□□□</b>
3	<b>3P11WP-Y□□□</b>
4	<b>3P11XP-Y□□□</b>

\*YF97 (White), YF96 (Gray), YF95 (Black)  
\*Order 4 receptacles for each module kit.

**(3) Hardwire power infeed**

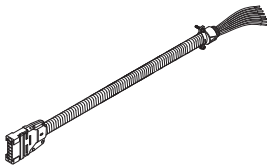

W	Item code
240"	<b>3P11LP-Y647</b>
120"	<b>3P11MP-Y647</b>
72"	<b>3P11NP-Y647</b>

**(4) Wiring duct cover**

For use without fixed screen		For use with fixed screen	
Bench W	Item code	Bench W	Item code
72"(70")	<b>3W7A0Y-ZF9□</b>	72"(70")	<b>3W9VAA-ZF9□</b>
66"(64")	<b>3W7A1Y-ZF9□</b>	66"(64")	<b>3W9VAB-ZF9□</b>
60"(58")	<b>3W7A2Y-ZF9□</b>	60"(58")	<b>3W9VAC-ZF9□</b>
54"(52")	<b>3W7A3Y-ZF9□</b>	54"(52")	<b>3W9VAD-ZF9□</b>
48"(46")	<b>3W7A4Y-ZF9□</b>	48"(46")	<b>3W9VAE-ZF9□</b>

\*ZF97 (White), ZF96 (Silver), ZF95 (Black)

**Electrical Diagram**

- Utilizes 8-wire, 4-circuit electrical module system as power source for each outlet in wiring duct.
- For every power infeed of 4-circuit electrical module system a 3 + 1 configuration is available as standard.
- All electrical module systems need to be installed in field with the back-to-back height adjustable table by furniture installer.
- 20-amp hardwire power infeed only. A licensed electrician is required to complete hardwire connections to building's power source.
- Hardwire power infeed is having 3 length (72"/120"/240") as standard. Other length hardwire power infeed is available as an option.
- Hardwire power infeed is flexible metal conduit as standard. Liquid-tight conduit option available.
- Neutral (White) wires are 10 gauge, hot and ground wires are 12 gauge.
- When specify, receptacles must be specified separately.
- Power source cables and desktop power outlets are UL listed for upholding strict safety standards.

**Chicago Electrical Requirements**

The city of Chicago may require hardwiring of electrical components. For Chicago applications, please contact your local representatives or dealerships.

**Other Municipality Electrical Requirements**

Other metropolitan areas besides Chicago may have special electrical requirements as well. Consult a local electrical contractor for proper code compliance information.

Electrical diagram for Hardwire Power infeed.

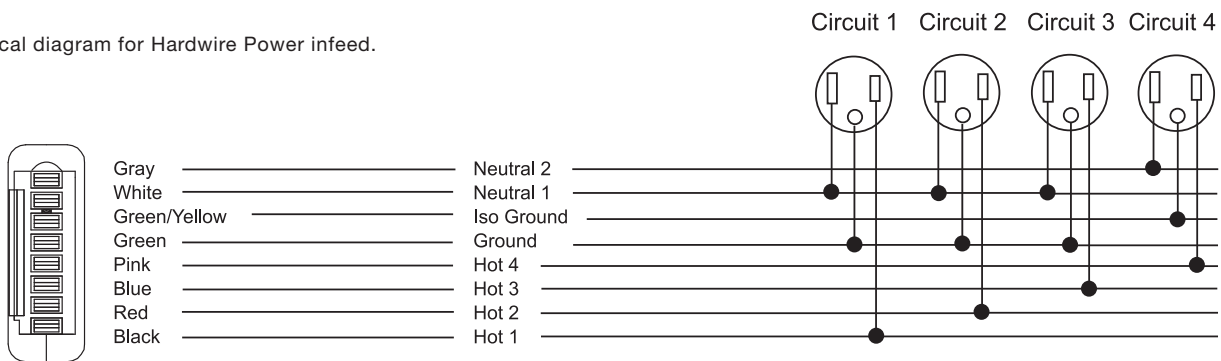

● The dimensions are indicated in inch.



**Cable Routing Diagram**

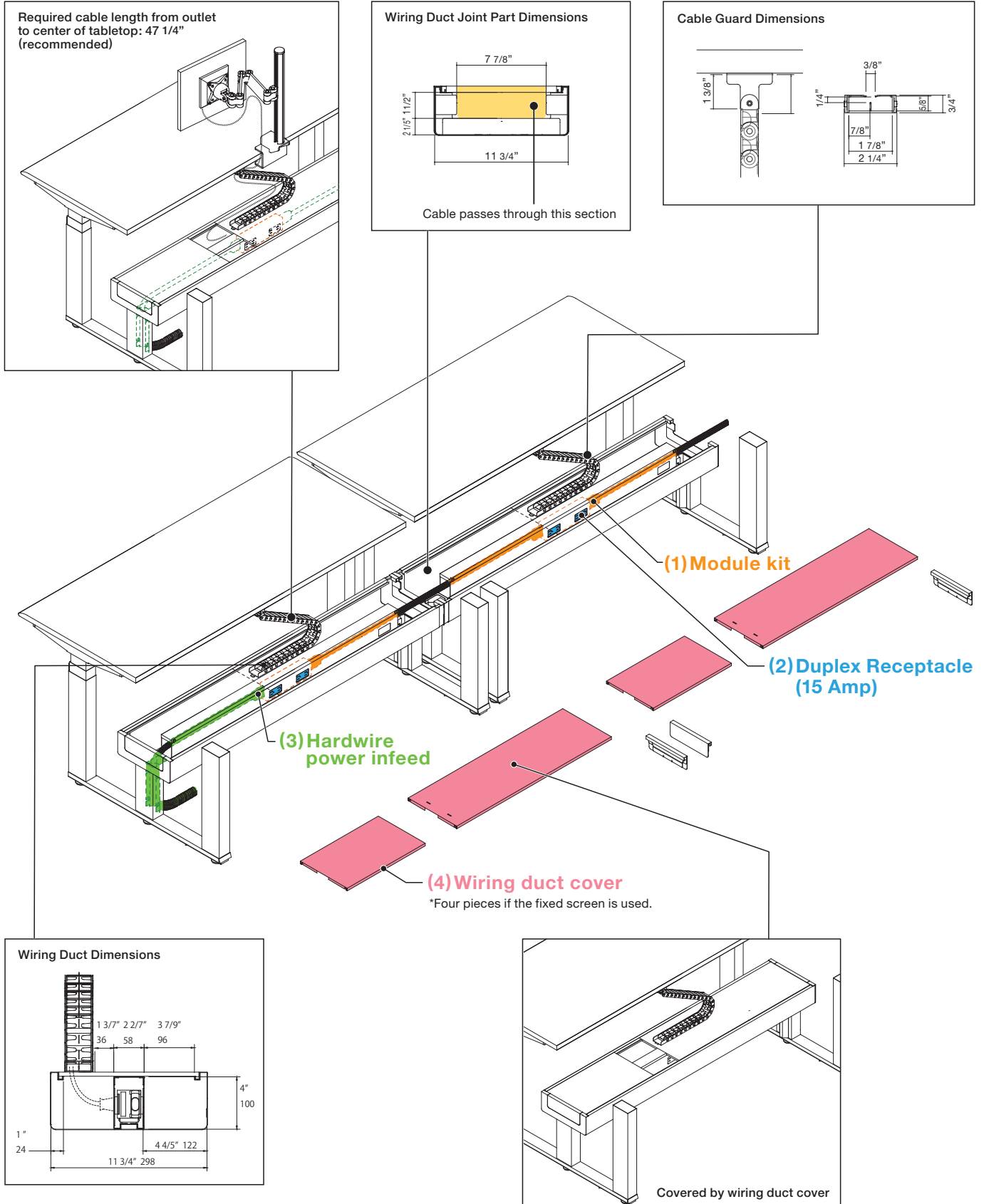

●The dimensions are indicated in inch.



Effective Dimensions From The Leg To The Duct

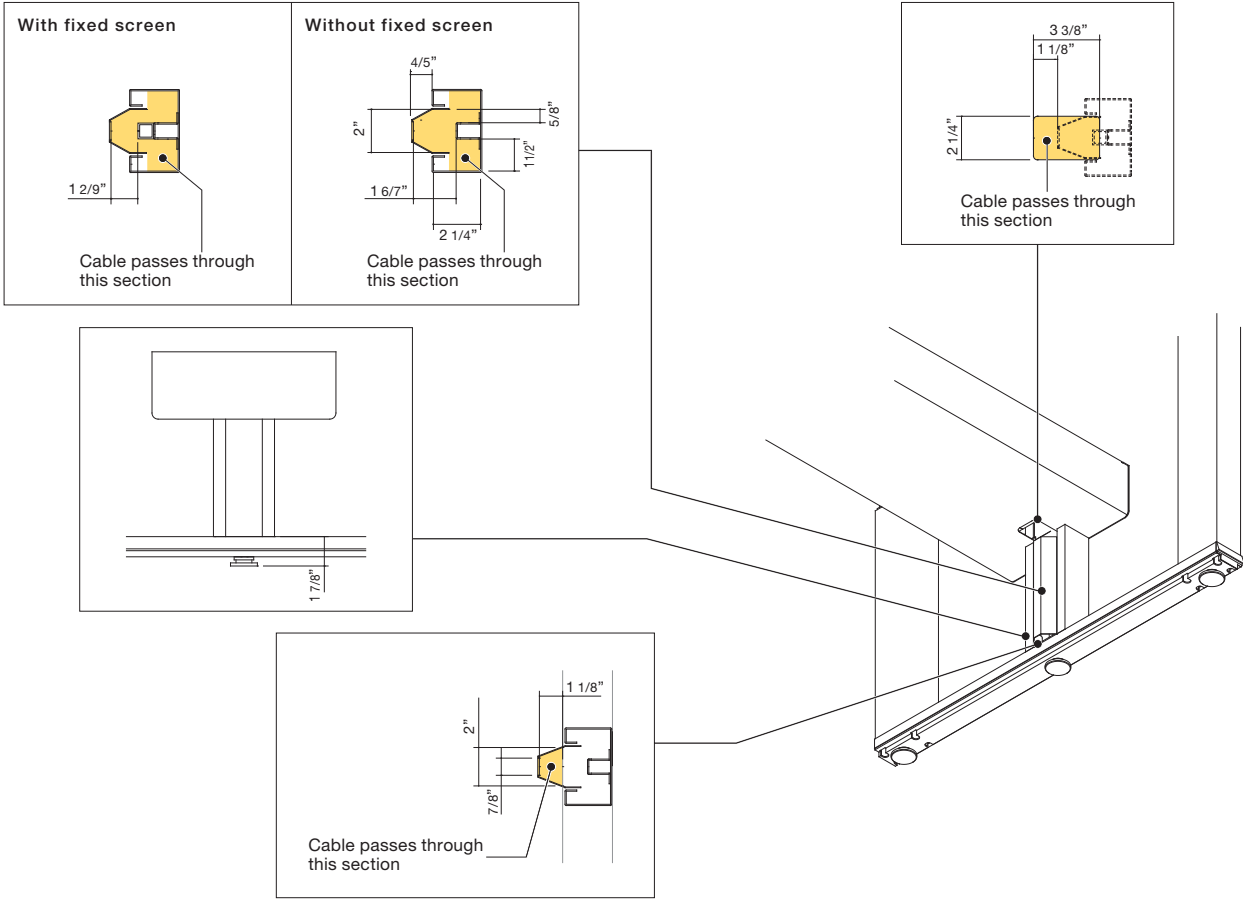

Power Infeed Floor Entry Location

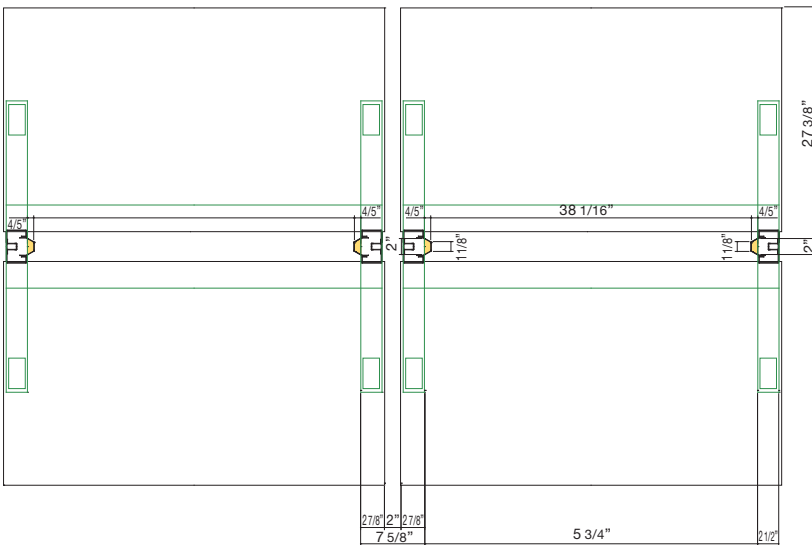

Clamp-free Zone Dimensions

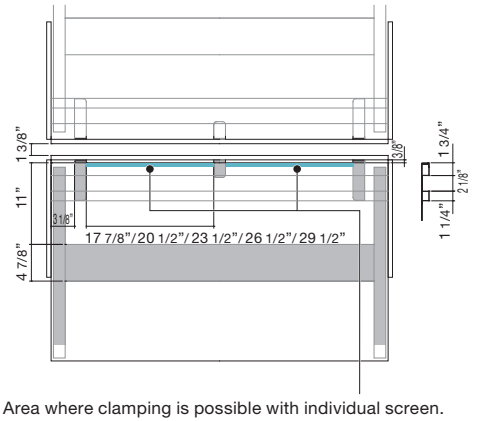

●The dimensions are indicated in inch.

Options

■ Cable guard  
(Free standing type / L-shaped type)

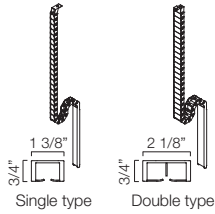

Single duct type cable guard

**3W641Y-ZF□□**

Double duct type cable guard

**3W646Y-ZF□□**

ZF95 (Black)

ZF96 (Silver)

ZF97 (White)

\*Prepare a cable with a length of 59".

■ Cable tray (large-capacity type)

Type	Desk W	Item code
For free standing type, bench type	72"(70")	<b>3W636Y-G473</b>
	66"(64")	<b>3W637Y-G473</b>
	60"(58")	<b>3W638Y-G473</b>
	54"(52")	<b>3W639Y-G473</b>
For L-shaped type	72"×72"(70"×70")	<b>3W695Y-G473</b>
	66"×66"(64"×64")	<b>3W697Y-G473</b>

Technical diagrams show dimensions for Large-capacity type (28 3/8" height, 3 3/8" width, 24 3/8" depth) and Standard type (reference) (28 3/8" height, 3 3/8" width, 25 5/8" depth).

2 piece / set G473 (Black)

\*Replace the cable tray included in the desk (standard type) with this tray.

\*The only wagon model that can be used in combination with the large-capacity type is the stool wagon (with a drawer + a pen tray).

■ Reinforcement bracket for display arm

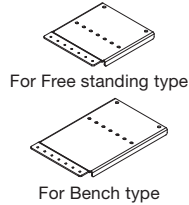
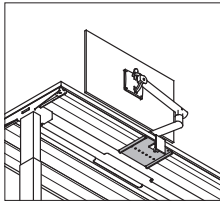

For Free standing type

**3W921P-Z25**

For Bench type

**3W926P-Z25**

\*Only one bracket can be installed on each desk.

■ Opposite table connector



For Free standing and L-shaped types

**3W971Y-G□□□**

2 pieces / set

When laying out desks opposite each other, attach these connectors to the end legs. Please order enough connectors for the number of end legs you wish to connect.

G975 (Neo White)

G204 (Black)

G636 (Skip Gray)

■ Floor fixing bracket



**3W990Y-Z606**

4 pieces / set

Z606 (Skip Gray)

\*Fixed on the floor and grab the leveler of the table base.

\*Screws are not supplied.

■ Desktop power unit



Power×3

**3P13AY-Y□□□**

Cable length:120"

Y707 (White)

Y708 (Black)



Power×2, USB×2

**3P13BY-Y□□□**

Cable length:120"

Y707 (White)

Y708 (Black)

●The dimensions are indicated in inch.

**Options**

■ Desktop shelf

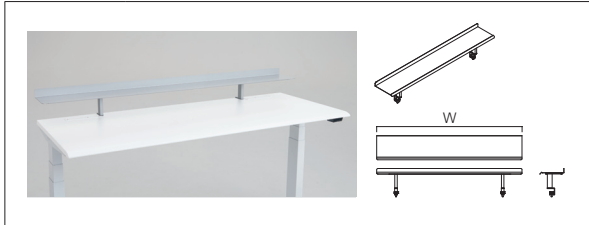

Desk W	D	H	Item code
72"(70")	7 5/16"	5 1/8"	<b>DD87EA-Z</b> □□□
66"(64")			<b>DD87EB-Z</b> □□□
60"(58")			<b>DD87ED-Z</b> □□□
54"(52")			<b>DD87EE-Z</b> □□□
48"(46")			<b>DD87EF-Z</b> □□□

Maximum loading capacity : 11lbs (5kg)

\*Clamp-mount.

\*Smaller shelves than the desk can also be installed.

Z975 (Neo White), Z637 (Skip Silver), Z25 (Black)

■ Felt storage

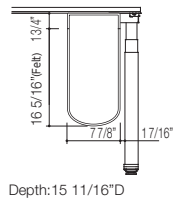

Depth: 15 11/16"D

**DD54BA-ZF9**□□□

Maximum loading capacity : 11lbs (5kg)

■ Felt storage with a metal drawer

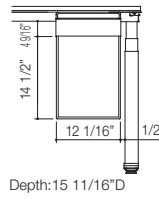

Depth: 15 11/16"D



The drawer comes with a lock. You can use it to store stationery and other valuable items.

For Free standing type, L-shaped type  
27 5/8"D models

**DD54AA-ZF9**□

Maximum loading capacity : 11lbs (5kg)

Usable inside dimensions of the drawer:

8 11/16"W×10"D×2 11/16"H Lock included

For the 27 5/8"D Bench type

**DD54AC-ZF9**□

■ Metal storage

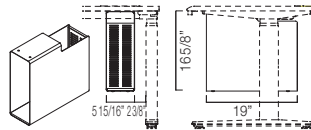

For Free standing type, L-shaped type

**3S800Y-ZF9**□

For Bench type

**3S801Y-ZF9**□

Common colors: ZF97 (White), ZF96 (Silver), ZF95 (Black)

5 7/8"W×18 7/8"D×16 5/8"H Maximum loading capacity : 33lbs (15kg)

Applicable PC size: 4 5/16"W or less, 13 3/4"H or less, 16 1/8"D or less

**Options**

■ **Pencil drawer**

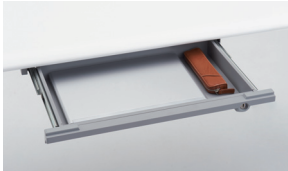

External dimensions			Usable inside dimensions			Type	Item code	Installation capacity		
W	D	H	W	D	H			Free standing type 30"(29")D	L-shaped type	Bench type 30"(29")D
20 1/16"	15 3/4"	1 9/16"	16 7/8"	13 11/16"	1 1/4"	Shallow	<b>DD48NC-Z606 / Z25</b>	1	Not installable	Not installable
		2 3/16"		13 1/4"	2"	Deep	<b>DD48ND-Z606 / Z25</b>	1	Not installable	Not installable
	11 13/16"	1 9/16"		10 3/16"	1 1/4"	Shallow	<b>DD48NH-Z606 / Z25</b>	1	2	1
		2 3/16"		9 13/16"	2"	Deep	<b>DD48NJ-Z606 / Z25</b>	1	2	1
	9 7/8"	1 9/16"		8 1/4"	1 1/4"	Shallow	<b>DD48EG-Z606 / Z25</b>	Not installable	Not installable	1
		2 3/16"		7 13/16"	2"	Deep	<b>DD48EH-Z606 / Z25</b>	Not installable	Not installable	1

Lock and cable hole included.

Z606 (Skip Gray)  
Z25 (Black)

■ **Pedestal**



**Pedestal side handgrip**  
**3W33AA-Z□□□**  
15 3/8"W×22 7/8"D×22 1/8"H

Inside dimensions: Upper Pen tray drawer 12 1/2"W×17 5/8"D×1 5/8"H, Center Ordinary drawer 12 1/2"W×17 1/4"D×7"H, Lower filing drawer (A4 size) 12 1/2"W×20 1/2"D×10 3/8"H



**Pedestal front handgrip**  
**3WC3AA-Z□□□**  
15 3/8"W×22 7/8"D×22 1/8"H



**Pedestal with a drawer + a pen tray**  
**3W31BZ-Z□□□**  
15 3/8"W×22 7/8"D×15 3/4"H

With two partition plates and a latch (filing drawer), an all-locking key (with lock / release display), caster stoppers, rollers for overturning prevention



**Stool pedestal**  
**With a drawer + a pen tray, side handgrip**  
**3W31BX-Z□□□**  
15 1/2"W×22 7/8"D×17 3/8"H

With two partition plates, a latch (filing drawer), an all-locking key (with lock / release display), caster stoppers, rollers for overturning prevention, a pen tray drawer (inside dimensions: 12 1/2"W×17 5/8"D×1 5/8"H), a B4/A4 filing drawer (inside dimensions: 12 1/2"W×20 1/2"D×11 1/2"H)

Common specifications: An all-locking key (with lock / release display), caster stoppers, rollers for overturning prevention, a latch. Each filing drawer or ordinary drawer has one partition plate.  
Common colors: Z25 (Black), Z637 (Skip Silver), Z975 (Neo White)

●The dimensions are indicated in inch.

**Basic Table Specifications**

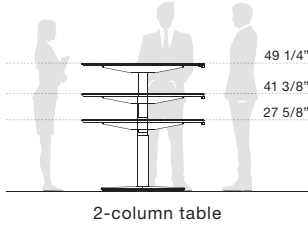

2-column table

The tabletop height of the meeting table can be adjusted within the range from 27 5/8" to 49 1/4".

\*With a safety reverse function that moves the desk approximately 1 inch backward (approximately 1 1/8" when the desk is moved slowly) immediately when the desk hits an obstacle as standard  
 \*Rated voltage 120 V, rated frequency 60Hz  
 \*Rated power consumption: 300W

**Basic Table Specifications (wide type)**

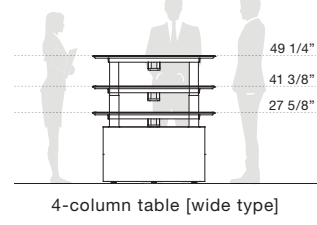

4-column table [wide type]

The tabletop height of the meeting table (wide type) can be adjusted within the range from 27 5/8" to 49 1/4".

\*With a safety reverse function that moves the desk approximately 1 inch backward (approximately 1 1/8" when the desk is moved slowly) immediately when the desk hits an obstacle as standard  
 \*Rated voltage 120 V, rated frequency 60 Hz  
 \*Rated power consumption: 600W

**Control panel**



Lever type (with indicator)



Lever type (without indicator)

The lever type control panels allow you to lift or lower the desk more intuitively. You can select from two versions: the one with indicator including a height display and a memory function which allows you to save your three preferred heights, the simpler one without indicator which only includes a lifting and lowering function.

**7 tabletop colors**



The entire circumference is equally curved. The molded resin structure gives the surface a soft feel.

**Cable opening**



The cable cover can be opened and closed. A spacious opening allows you to store power strips and similar equipment inside. When not using the cable duct, use the cover to close it completely.

**Color**

\*Common with the wide type

**Leg color**



ZF97 White    ZF96 Silver    ZF95 Black

**Table top color** \*Anti-fingerprint laminate

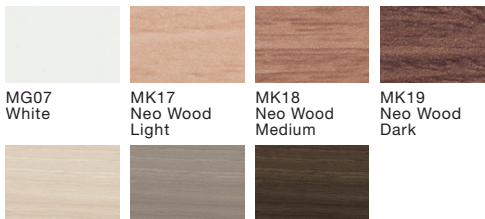

MG07 White    MK17 Neo Wood Light    MK18 Neo Wood Medium    MK19 Neo Wood Dark  
 MX51\* Prize Wood Light    MX52\* Prize Wood Medium    MX53\* Prize Wood Dark

**Table combination code**

Combination code	Part name / code		Combination code	Part name / code		Combination code	Part name / code	
	Table top	Body		Table top	Body		Table top	Body
MY30 (White)	MY01	MG07 (Laminate: White)	MY20 (White)	MY01	MG07 (Laminate: White)	MY10 (White)	MY01	MG07 (Laminate: White)
		GC70 (Edge: Pale Gray)			GC70 (Edge: Pale Gray)			GC70 (Edge: Pale Gray)
MY32 (Neo Wood Light)	MK37	MK17 (Laminate: Neo Wood Light)	MY22 (Neo Wood Light)	MK37	MK17 (Laminate: Neo Wood Light)	MY12 (Neo Wood Light)	MK37	MK17 (Laminate: Neo Wood Light)
		G947 (Edge: Neo Wood Light)			G947 (Edge: Neo Wood Light)			G947 (Edge: Neo Wood Light)
MY33 (Neo Wood Medium)	MK38	MK18 (Laminate: Neo Wood Medium)	MY23 (Neo Wood Medium)	MK38	MK18 (Laminate: Neo Wood Medium)	MY13 (Neo Wood Medium)	MK38	MK18 (Laminate: Neo Wood Medium)
		G948 (Edge: Neo Wood Medium)			G948 (Edge: Neo Wood Medium)			G948 (Edge: Neo Wood Medium)
MY34 (Neo Wood Dark)	MK39	MK19 (Laminate: Neo Wood Dark)	MY24 (Neo Wood Dark)	MK39	MK19 (Laminate: Neo Wood Dark)	MY14 (Neo Wood Dark)	MK39	MK19 (Laminate: Neo Wood Dark)
		G949 (Edge: Neo Wood Dark)			G949 (Edge: Neo Wood Dark)			G949 (Edge: Neo Wood Dark)
MBL2 (Prize Wood Light)	MX61	MX51 (Laminate: Prize Wood Light)	MBK2 (Prize Wood Light)	MX61	MX51 (Laminate: Prize Wood Light)	MBJ2 (Prize Wood Light)	MX61	MX51 (Laminate: Prize Wood Light)
		GE21 (Edge: Prize Wood Light)			GE21 (Edge: Prize Wood Light)			GE21 (Edge: Prize Wood Light)
MBL3 (Prize Wood Medium)	MX62	MX52 (Laminate: Prize Wood Medium)	MBK3 (Prize Wood Medium)	MX62	MX52 (Laminate: Prize Wood Medium)	MBJ3 (Prize Wood Medium)	MX62	MX52 (Laminate: Prize Wood Medium)
		GE22 (Edge: Prize Wood Medium)			GE22 (Edge: Prize Wood Medium)			GE22 (Edge: Prize Wood Medium)
MBL4 (Prize Wood Dark)	MX63	MX53 (Laminate: Prize Wood Dark)	MBK4 (Prize Wood Dark)	MX63	MX53 (Laminate: Prize Wood Dark)	MBJ4 (Prize Wood Dark)	MX63	MX53 (Laminate: Prize Wood Dark)
		GE23 (Edge: Prize Wood Dark)			GE23 (Edge: Prize Wood Dark)			GE23 (Edge: Prize Wood Dark)

●The dimensions are indicated in inch.

2-column Table

With cable opening

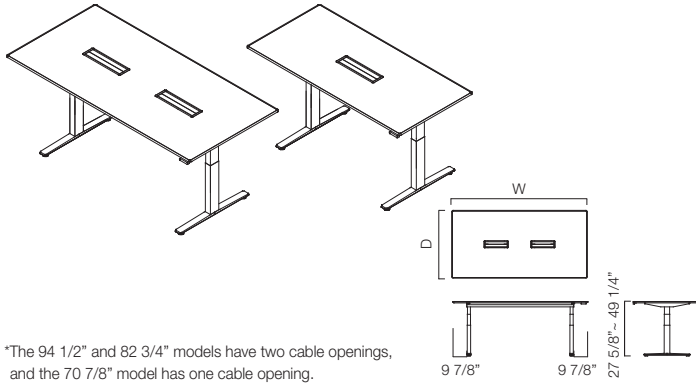

\*The 94 1/2" and 82 3/4" models have two cable openings, and the 70 7/8" model has one cable opening.

Without cable opening

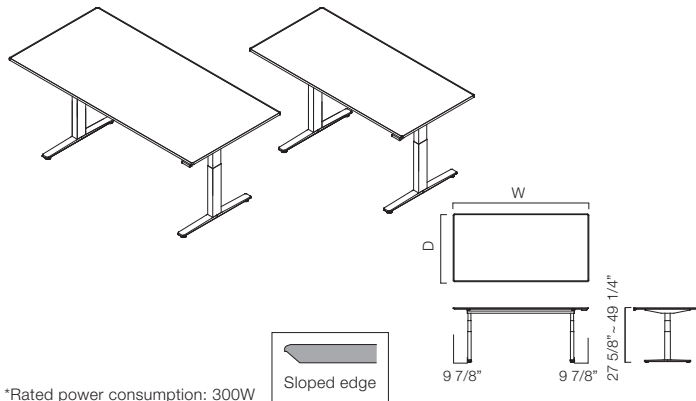

\*Rated power consumption: 300W

Cable opening	Control panel		W	D	H	Item code
Yes	Lever type	with indicator	94 1/2"	47 1/4"	49 1/4" 27 5/8"	<b>3W27AE-MY</b> □□
			82 3/4"	43 3/8"		<b>3W27AF-MY</b> □□
		without indicator	70 7/8"	35 1/2"		<b>3W27AG-MY</b> □□
	without indicator		94 1/2"	47 1/4"		<b>3W27BE-MY</b> □□
		82 3/4"	43 3/8"	<b>3W27BF-MY</b> □□		
		70 7/8"	35 1/2"	<b>3W27BG-MY</b> □□		
No	Lever type	with indicator	94 1/2"	47 1/4"	49 1/4" 27 5/8"	<b>3W27CE-MY</b> □□
			82 3/4"	43 3/8"		<b>3W27CF-MY</b> □□
		without indicator	70 7/8"	35 1/2"		<b>3W27CG-MY</b> □□
	without indicator		94 1/2"	47 1/4"		<b>3W27EE-MY</b> □□
		82 3/4"	43 3/8"	<b>3W27EF-MY</b> □□		
		70 7/8"	35 1/2"	<b>3W27EG-MY</b> □□		

Option

■ Vertical cable guard



**3W288Z-G764**

G764 (Clear)

\*Use a vertical cable guard to prevent the power cord from breaking.

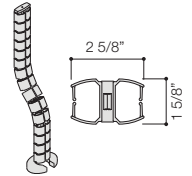

■ Required items and options

Item	Required / Option
Table	Required
Vertical cable guard	Option

4-column Table (wide type)

With cable opening

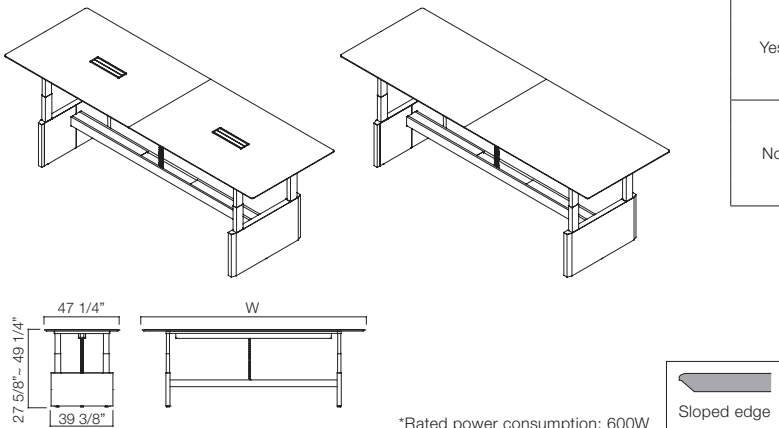

\*Rated power consumption: 600W

Cable opening	Control panel		W	D	H	Item code
Yes	Lever type	with indicator	141 3/4"	47 1/4"	49 1/4"	<b>3W27KF-MY</b> □□
			118 1/8"			27 5/8"
	without indicator		141 3/4"		118 1/8"	<b>3W27LF-MY</b> □□
		118 1/8"	<b>3W27LH-MY</b> □□			
No	Lever type	with indicator	141 3/4"	47 1/4"	49 1/4"	<b>3W27KK-MY</b> □□
			118 1/8"			27 5/8"
	without indicator		141 3/4"		118 1/8"	<b>3W27LK-MY</b> □□
		118 1/8"	<b>3W27LL-MY</b> □□			

\*With integrated cable guides

**OKAMURA**

OKAMURA CORPORATION

International Sales & Marketing Div.

2-14-27, Akasaka, Minato-ku, Tokyo 107-0052, JAPAN

Tel: +81-3-5561-4085 Fax: +81-3-5561-4086

<http://www.okamura.com>

The products listed in this catalog are available as of July 2019. Please note that specifications, dimensions, and colors are subject to change without notice. The colors of the actual products may differ somewhat from the colors shown in the catalog, depending on printing conditions.