

Portone



okamura

Design that flexibly
supports your best posture.



The union of style and comfort. The pliable frame harmonizes
with your movements as the lumbar support comfortably contours the curves of your back.
A design born of Okamura's fascination with ergonomics.

Portone

There are Two Types of Portone According to Reclining Functions

Smart type

Standard type

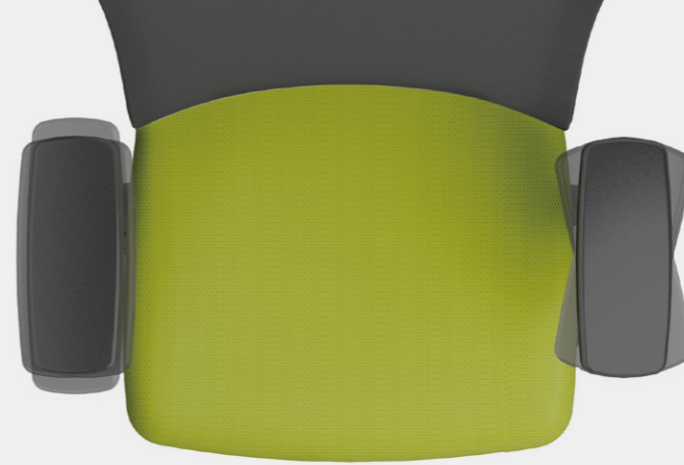

■ Pliable Frame

The backrest flexes with the motion of your body. The bend comfortably accommodates natural side-to-side movement.

■ Adjustable Lumbar Support

The supple lumbar support fortifies your body's core, reinforcing a healthy posture.

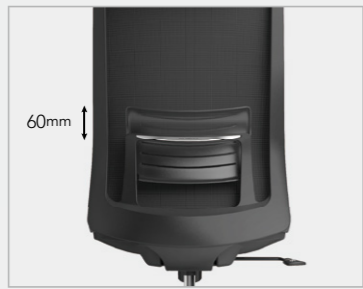

The lumbar support easily adjusts to match your physical requirement. To adjust, simply grasp the lower ridge of the lumbar support and push up or down.

■ Adjustable Seat Height

Adjust the height of the seat by pulling up the lever under the seat on the right range : 120mm



Smart type

Standard type

■ Adjustable Seat Depth

Adjust the depth of the seat by operating the lever under the seat on the right (Smart type), left (Standard type)

range
Smart type : 52mm / 4 levels fixed
Standard type : 55mm / 4 levels fixed



Smart type

Standard type



■ Adjustable Arms (3D Arms)

The up and down [1D], angle [2D], back and forth [3D], positioning of the arm pads adjustable. The respective movable ranges are 62mm for up and down, 15 degrees for inside, 15 degrees for outside, 40mm for back and forth.

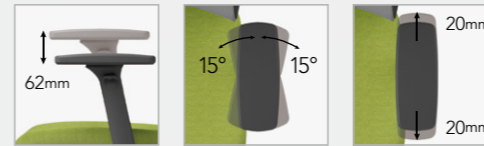

Headrest (Option)

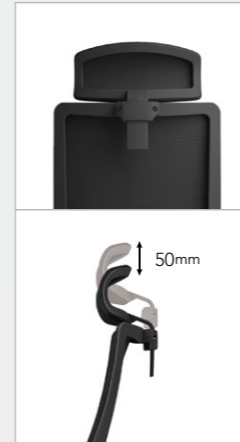

Headrest height can be adjusted by sliding up (range : 50mm).

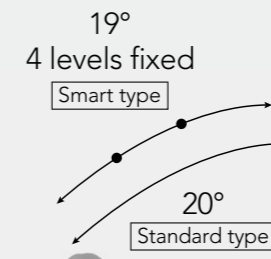

■ Smart Fit Reclining [Smart Type]

The chair automatically adjusts the reclining tension in to a sitter's weight, regardless of each person's unique physical differences.

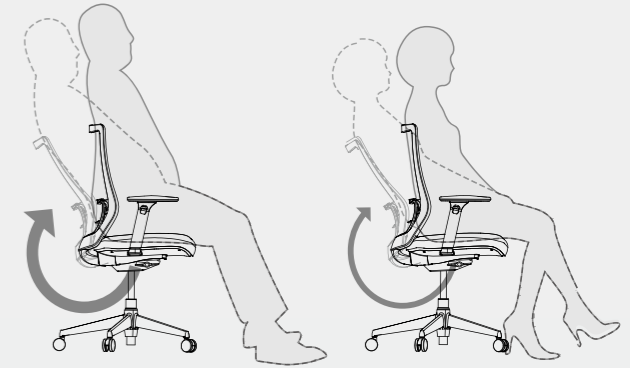

Reclining reaction force : Strong

Reclining reaction force : Weak

The backrest can be locked and released by operating the lever under the seat on the right (4 levels fixed)

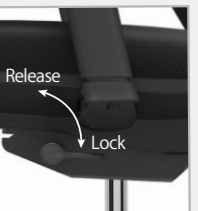

■ Reclining [Standard Type]

1 Reclining Tension Adjustment
Reclining tension can be adjusted by rotating the dial under the center of the seat. Turn clockwise to increase tension, or counterclockwise to reduce tension.

2 Lock and Release of Backrest
The backrest can be locked (in upright position only) by pushing in the lever under the seat on the left. To release, simply pull the lever out.



Back Colors

Gray Body

Light Gray Mesh



Black Body

Black Mesh



Seat Colors

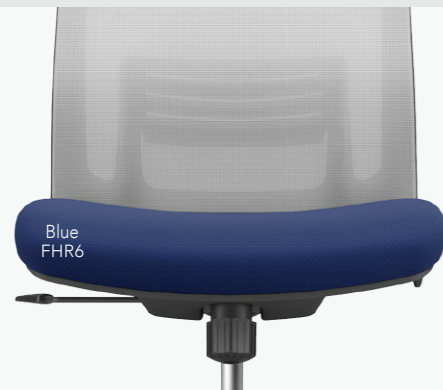

Armrest Type

3D Adjustable Arms



Armless



Base Type

Polished (Black/Gray Body)



Black (Black Body)

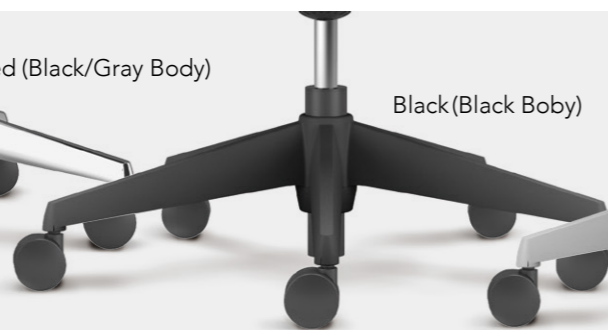

Gray (Gray Body)



Chair type



High Back



High Back with headrest

		Portone Smart	Portone Standard
Adjustable Seat	Height	120mm	120mm
	Depth	4 levels fixed 52mm	4 levels fixed 55mm
Reclining	Angle	4 levels fixed 19°	fixed (Upright position only) 20°
	Tension	Smart fit Reclining	Dial adjustment

Dimensions *mm

High Back

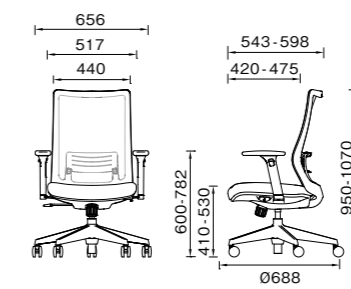

3D Adjustable Arms

High Back with headrest

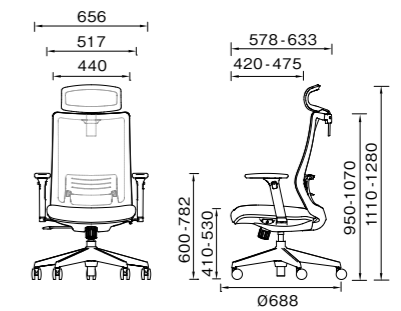

3D Adjustable Arms



Indoor Advantage certified

Indoor Advantage certification assures that furniture products support a healthy indoor environment by meeting strict indoor air quality (IAQ) chemical emission limits for volatile organic compounds (VOCs). To be certified, products must be tested by independent labs for compliance with the ANSI/BIFMA X7.1, Furniture Emission Standard, for VOC emissions for concern.

okamura